



Webelos Den Meeting Plans

Den meeting plans are developed around a Scouting program year that is presumed to begin in early September and continue through May, at which time Cub Scouts would become involved in summertime Scouting activities. Two types of den meeting plans are offered for the den leader's use:

- ▶ Numbered plans: Programming for the program/school year (September through May), including rank advancement requirements for dens meeting twice a month

Webelos Den Meeting Plans

Meeting Date	Den Meeting Plan No.	Achievements to Complete the Webelos Badge	Rank Requirements and Electives Covered
	1	Fitness and Athlete	Do: Fitness 1 <i>and six</i> from 2–8 Athlete 1–7 Bobcat Review HA*: Complete Fitness 2–7. Complete Athlete 4–7. Review Forester and Naturalist chapters.
	2	Forester and Naturalist	Verify: Fitness 2–7 (complete) Do: Naturalist 1, 4, 8, and 10 Forester 3, 4, 9 HA: Review Forester and Naturalist chapters.
	3	Forester and Naturalist	Do: Forester 5 and 6 Naturalist 6, 7, and 9 HA: Review Traveler chapter.
	4	Traveler and Athlete	Verify: Athlete 4–7 Do: Traveler 1, 9–12 (Geography belt loop) HA: Athlete 4–7. Webelos 8, review Citizen chapter.
	5	Citizen	Do: Citizen 1, 3, 8 (Citizenship belt loop) HA: Citizenship belt loop 1 and 3. Review Citizen chapter.
	6	Citizen	Verify: Citizenship belt loop 1 Do: Citizen 10, 8 (Citizenship belt loop 3) Webelos Review 3, 4, 7. Review Citizen chapter.
	7	Citizen	Do: Citizen 2–7 & 9 HA: Webelos Requirement 8. Review Artist chapter.
	8	Citizen and Artist	Verify: Citizen 8 (Citizenship belt loop 3), Webelos 1–8 Do: Citizen (make up) Webelos Review (make up) Artist 1, 4, 7, 9 HA: Review Geologist chapter.
	9	Geologist	Do: Geologist 1, 2, 8 HA: Review Geologist chapter.
	10	Geologist	Do: Geologist 4, 5, 6 HA: Review Engineer chapter.

Webelos Achievements:

- Webelos badge
- Compass points emblem and compass points
- Arrow of Light



The Webelos badge is the focus of the first year of Webelos.

	11	Engineer	Do: Engineer 2, 5, 6 HA: Review Engineer chapter.
	12	Engineer	Do: Engineer 1, 3, 4 HA: Review Craftsman chapter.
	13	Craftsman	Do: Craftsman 1, 2 HA: Review Craftsman, Scholar, and Artist chapters.
	14	Craftsman	Do: Craftsman 3, 4 HA: Scholar 11. Review Scholar and Artist chapters.
	15	Scholar	Do: Scholar 1, 5, 11, 12 Artist 2, 8, 10
	16	Showman (Puppetry)	Do: Showman 2–5, 7, 11, 17, 20
	17	Showman (Music)	Do: Showman 6, 8–15
	18	Showman (Drama)	Do: Showman 3, 11, 16–18, 20–23

Webelos Rank Requirements

There are three types of Webelos-level achievements, and they overlap each other and the two years of the Webelos program:

- ▶ The Webelos badge
- ▶ The compass points emblem and compass points
- ▶ The Arrow of Light

The Webelos badge is the focus of the first year of Webelos Scouting and requires the completion of three activity badges. The goal for many boys, and the focus of Webelos second year, is the Arrow of Light (which requires five more activity badges, plus other requirements). A Scout can also earn the compass points emblem by completing additional activity badges and the Webelos Super Achiever badge by doing earning all 20 activity badges.

The chart on the previous page shows the advancement plan covered by the den meeting plans in the *Den & Pack Meeting Resource Guide*. It is recommended that these den meeting plans be conducted in sequential order. However, the den leader may choose to alter the order to achieve the following:

- A. Deal with schedules of your Scouts and their other extracurricular activities.
- B. Follow your pack activities (for example, covering Outdoorsman elements before or at a pack campout).
- C. Line up with special guest volunteers who can come in to cover a topic that lines up with their occupation, hobby, or interest.
- D. Aligns with the den leader, assistant den leader, and parent’s interests and skills as it relates to optional activity badges.

If you make changes, be sure that the order and content of your meetings keeps you on track to complete your Webelos rank by the blue and gold banquet, which is likely to be held in February (check with your pack for scheduling) and that the necessary requirements for the badge of rank will be met.

- ▶ Note that while there are some fixed requirements and required activity badges (See the following page and pages 49–50 of the *Webelos Handbook*.), there is more than one way to do the achievements and earn the badge—you get to pick the rest of the activity badges that work for you.
- ▶ You should use the way that is the most fun for the Scouts, and easy to accomplish for you (the leader), especially by using other parent and community resources! **Keep It Simple, Make It Fun.**

Certain activities are **primarily done at home and signed off in the handbook by the parent** or adult family member after the boy has completed each task (the parent is sometimes referred to as “Akela” in the handbook and the achievement tasks). The handbook is later shown to the den leader or assistant, who records the progress and also signs the boy’s book



Webelos Rank Requirements

Achievements	Den Meeting Number
Webelos Badge	
1. Have an adult member of your family read the Webelos Scout Parent Guide (pages 1–22) and sign here.	Webelos Meeting 8
2. Be an active member of your Webelos den for three months. (<i>Active means having good attendance, paying your den dues, and working on den projects.</i>)	Webelos Meeting 8
3. Know and explain the meaning of the Webelos badge.	Webelos Meetings 6 and 8
4. Point out the three special parts of the Webelos Scout uniform. Tell when to wear the uniform and when not to wear it.	Webelos Meetings 6 and 8
5. Earn the Fitness and Citizen activity badges and one other activity badge from a different activity group.	Webelos Meeting 8
6. Plan and lead a flag ceremony in your den that includes the U.S. flag.	Webelos Meeting 8
7. Show that you know and understand the requirements to be a Boy Scout: <ol style="list-style-type: none"> Demonstrate the Scout salute, Scout sign, and Scout handshake. Explain when you would use them. Explain the Scout Oath, Scout Law, Scout motto, and Scout slogan. Explain and agree to follow the Outdoor Code. 	Webelos Meetings 6 and 8
8. Faith After completing the rest of requirement 8, do these (a, b, and c): <ol style="list-style-type: none"> Know: Tell what you have learned about faith. Commit: Tell how these faith experiences help you live your duty to God. Name one faith practice that you will continue to do in the future. Practice: After doing these requirements, tell what you have learned about your beliefs. And do one of these (d OR e): <ol style="list-style-type: none"> Earn the religious emblem of your faith. * Do two of these: <ul style="list-style-type: none"> Attend the mosque, church, synagogue, temple, or other religious organization of your choice; talk with your religious leader about your beliefs. Tell your family and your Webelos den leader what you learned Discuss with your family and your Webelos den leader how your religious beliefs fit in with the Scout Oath and Scout Law and what character-building traits your religious beliefs have in common with the Scout Oath and Scout Law. With your religious leader, discuss and make a plan to do two things you think will help you draw nearer to God. Do these things for a month. For at least a month, pray or meditate reverently each day as taught by your family and by your church, temple, mosque, synagogue, or religious group. Under the direction of your religious leader, do an act of service for someone else. Talk about your service with your family and your Webelos den leader. Tell them how it made you feel. List at least two ways you believe you have lived according to your religious beliefs. 	Webelos Meetings 4, 7, and 8

Webelos Rank Requirements

Activity Badge Requirements		Den Meeting Number
Fitness (Physical Skills)		1-4
Citizen (Community)		5-8
One More From Different Activity Group		
Mental Skills	Artist	8 and 15
	Traveler	4
	Scholar	15
Technology	Craftsman	13-14
	Engineer	11-12
Outdoor	Forester	2-3
	Naturalist	2-3
	Geologist	4-10





Webelos Den Meeting 1

Fitness and Athlete

Before the Meeting

- ▶ Make final preparations with assistance from any assistant den leader or other parent helper, den chief, and/or denner. Organize the space (seating, flags, advancement charts, activity materials, handouts, etc.). If you're snacking, organize space for that and the cleanup.

Gathering

- ▶ Welcome new and returning Scouts and parents.
- ▶ Get to know parents/engage them in the meeting.
- ▶ Have a gathering activity (games, puzzles, other) that will keep Scouts interested and busy and that others may join as they arrive. If the den desires, serve a healthy snack during this time.
- ▶ Collect dues, record attendance and any advancement completed over the summer (a good job for an assistant den leader).

Opening

- ▶ Flag ceremony (rotate planning and leadership to complete **Webelos requirement 6**), with Pledge of Allegiance; maybe recite the Cub Scout Promise or sing a patriotic song; perhaps add a roll call, uniform recognition, or den yell.
- ▶ Provide index cards printed with the Cub Scout Promise and Law of the Pack for any new boys.
- ▶ If you have a guest, give a formal introduction, including what the guest will do for you.

Business Items

- ▶ This meeting will have lots of organizational and getting-to-know talk.
- ▶ Have each Scout (and attending parent) introduce themselves.
- ▶ Discuss/remind what a den is, and how it fits in with a pack. Discuss your goals for the year and highlight/promote the cool activities. Discuss a den name, den yell, and other den identity elements (could include flag, totem, or neckerchief slide).
- ▶ Remind boys of behavioral expectations at den meetings. This is an opportunity to create your den's code of conduct for how the den should govern itself during meetings.
- ▶ Use this time also to discuss participation in upcoming pack meetings or events as needed.
- ▶ Explain that today's meeting is to review Bobcat knowledge and requirements, plus to plan for upcoming Webelos events—to work on the **Fitness and Athlete activity badges** because the Webelos Scouts need to help plan where to go and how to get there.

Activities

- ▶ **Review Bobcat Requirements** (*if needed*): Cub Scout Promise; Law of the Pack; Cub Scout motto, sign, handshake, salute; meaning of *Webelos*.
- ▶ **Fitness Activity Badge:** Requirements are to do 1 and six from 2–8.
 1. With your parent, guardian, or Webelos den leader, complete the Health and Fitness Character Connection.
 - a. **Know:** Tell why it is important to be healthy, clean, and fit.
 - b. **Commit:** Tell when it is difficult for you to stick with good health habits. Tell where you can go to be with others who encourage you to be healthy, clean, and fit.
 - c. **Practice:** Practice good health habits while doing the requirements for this badge.
 - Doing this in small groups helps allow each Scout to participate more fully, but you may elect to discuss as an entire den, especially in this introductory meeting.
 2. With a parent or other adult family member complete a safety notebook, which is discussed in the booklet *How to Protect Your Children From Child Abuse: A Parent's Guide* that comes with the handbook.
 - This is an "at home" project, but you may elect to discuss this with the den as well.
 3. Read the meal planning information in this chapter. With a parent or other family member, plan a week of meals. Explain what kinds of meals are best for you and why.



4. Keep a record of your daily meals and snacks for a week. Decide whether you have been eating foods that are good for you.
 - Review the handouts for 3 and 4 that you will ask the Scouts to complete and return.
 - If you have access to a computer, go to www.mypyramid.gov/mypyramid/index.aspx and create personal pyramids tailored to your size, age, and activity level.
 5. Tell an adult member of your family about the bad effects smoking or chewing tobacco would have on your body.
 6. Tell an adult member of your family four reasons why you should not use alcohol and how it could affect you.
 7. Tell an adult member of your family what drugs could do to your body and how they would affect your ability to think clearly.
 - These could be done at home, but you may elect to discuss this with the den as well.
 8. Read the booklet *Choose to Refuse! Take A Stand Against Drugs!* Discuss it with an adult and show that you understand the material.
 - If you do not have these booklets, this will be the extra requirement you do not do.
 - If you have the booklet, this could be done at home and in the den as well.

Note: *Choose to Refuse* is the standard booklet for this requirement and should be available through your council service center.
- This Fitness introduction is a good time, if you haven't done it yet, to have them plan what kind of snacks to have at den meetings for the rest of the year. More nutritious snack alternatives include:
- Hard cheese cut into cubes and served with whole wheat crackers and/or apple slices
 - Celery stalks filled with cheese spread or peanut butter
 - Fresh vegetables served with a dip
 - Peanut butter on bran muffins or whole wheat bread or crackers
 - Chopped nuts mixed with bits of dried fruit
 - Any kind of fruit. If available, try some unusual ones, such as kiwi, pomegranate, or mango.
- Note:** Check for food allergies among your boys—for someone with a peanut allergy, even being around peanuts can trigger an allergy attack.
- **Athlete Activity Badge:** Requirements are to do requirements 1–5, and then two of 6 through 10. (This meeting plan starts those first five, and adds 6 and 7):
1. With your parent, guardian, or Webelos den leader, complete the Perseverance Character Connection.
 - a. **Know:** Review the requirements and decide which ones might be more difficult for you to do. Make a plan to complete one of the harder requirements.
 - b. **Commit:** When doing the harder requirement, did you ever feel frustrated or angry? What did perseverance have to do with that? Name another type of task for which you will need to persevere.
 - c. **Practice:** Practice perseverance by following your plan to do that requirement for the Athlete activity badge.
 2. Explain what it means to be physically and mentally healthy.
 3. Explain what you as a Webelos Scout can do to stay physically and mentally healthy.
 - You might cover 1, 2, and 3 as a group discussion, and then when you start the physical skills, you and other parents might then ask the Webelos Scouts to explain and demonstrate their knowledge of these.
 - So you can do an activity, and while recovering, do the 1, 2, 3 question-and-answer signoffs.

Want More Fun in Your Activities?

This is a terrific day to jazz up with excitement. Consider themes like a track meet. Maybe have an MC or announcer for each event. Maybe someone with a video recorder can team up with a "sideline reporter" to get interviews with the contestants.

Den Meeting 1



4. Every time you work on requirement 5 below, start with at least five minutes of stretching warm-up activities.
 5. Do as many as you can of the following and record your results. Show improvement in all of the activities after 30 days.
 - a. Have another person hold your feet down while you do as many curl-ups as you can.
 - b. Do as many pull-ups from a bar as you can.
 - c. Do as many push-ups from the ground or floor as you can.
 - d. Do a standing long jump as far as you can.
 - e. Do a quarter-mile run or walk.
 6. Do a vertical jump and improve your reach in 30 days.
 7. Do a 50-yard dash as fast as you can, and show a decrease in time over a 30-day period.
 - For requirement 5, 6, and 7, record boys' initial results on the Athlete progress chart. Keep those charts for use in future meetings, since doing some or all of these is a great way to add physical activity, and the Scouts may be fired up to see if they have improved each time!
- ▶ In the boys' *Webelos Handbooks*, sign the requirements met (and update your records).
 - ▶ It is possible (especially if you have a good deal of Bobcat work) that this meeting will not be completed today. If so, carry over any incomplete elements to the next meeting that has a trip involved.

Closing

- ▶ Award (or recognize) any advancement completed today (ideally, award the activity badge or belt loop item completed today, and recognize later at the pack meeting); thank hosts, guests, helpers.
- ▶ Closing ceremony (rotate planning and leadership to complete **Webelos requirement 6**): Retire the colors; maybe with the Boy Scout Oath and/or Law, or the Law of the Pack and/or den yell. Den leader may add a den leader's minute comment.
- ▶ Remind the Webelos Scout who will plan and lead the next meeting's flag ceremony, and remind about home assignments (and include these in any family information letter or e-mail).
- ▶ Hand out or send family information letter.

▶ Home Assignment:

- Ask boys to complete Fitness activity badge requirements 2, 3, 4, 5, 6, and 7 at home with their parents/guardians, who should sign the boy's handbook on completion.
 - Ask boys to complete Athlete activity badge requirements 4–7.
- ▶ Read Naturalist and Forester chapters in *Webelos Handbook*.

After the Meeting

- ▶ If you've changed the sequence of den meetings, double-check to make sure you will still advance your boys appropriately and check with the Cubmaster to make sure you stay coordinated with the pack.
- ▶ Refreshments: If appropriate
- ▶ Cleanup: Recruit enough help to do a good job. Scouts always leave an area as clean, or cleaner, than they found it.

Webelos Scouts

Athlete Activity Badge Progress Record: Requirements 4-9
 Chart your progress over five weeks.

Name: _____



Week	1	2	3	4	5
Activity	___/___/___	___/___/___	___/___/___	___/___/___	___/___/___
Minutes of stretching/ warm-up activities					
Curl-ups (number)					
Pull-ups (number)					
Push-ups (number)					
Standing long jump (distance)					
Quarter-mile walk or run (time)					
Vertical jump (height)					
50-yard dash (time)					
(Optional) One-mile bike ride (time)					
(Optional) Quarter-mile swim (time)					



Webelos Fitness Activity Badge, Requirement 3

With a parent or other family member, plan a week of meals.

Name: _____

Day \ Meal	Breakfast	Lunch	Supper
Sunday			
Monday			
Tuesday			
Wednesday			
Thursday			
Friday			
Saturday			



Webelos Fitness Activity Badge, Requirement 4

Keep a record of your daily meals and snacks for a week.

Name: _____

Day \ Meal	Breakfast	Lunch	Supper	Snacks
Sunday				
Monday				
Tuesday				
Wednesday				
Thursday				
Friday				
Saturday				



This den meeting is normally done as a field trip. Are you ready?

Webelos Den Meeting 2

Naturalist and Forester

Preparation and Materials Needed

- ▶ Arrange to visit a museum of natural history, nature center, or zoo.
 - Or you might arrange for someone to bring items that might be in a nature center.
- ▶ Identify any parents or other pack resources who are interested in nature (on a working or hobby basis) and could be your activity badge counselor for this meeting. Or you might see if a science teacher, parks department naturalist, or other hobbyist can visit your den meeting.
 - Be sure any guest speaker knows how long the presentation should run, and that you've confirmed what can or should be covered that would be interesting and fun for the Scouts.
 - Show any guest speaker the Naturalist and Forester chapters in the *Webelos Handbook*.
- ▶ If you are doing this as a field trip, inform Scouts and families about when and where to meet.
- ▶ Materials checklist (add to your den Cub tub of U.S./den flags, paper/pencils, other supplies):
 - If you are not visiting a place with Naturalist resources, bring what you can (at least books or downloads of pictures of wildlife).
 - Tree books and materials about trees in your area.
 - Naturalist and Forester activity badge pins for each of your Scouts (so they can be awarded if completed today).
 - A slice of tree trunk showing growth rings. More, if possible, to show different growth patterns. Use cut lumber if tree trunks are not available.

Before the Meeting

- ▶ Review After the Meeting at the end of the previous den meeting plan for necessary preparation and materials.
- ▶ Make final preparations with assistance from any assistant den leader or other parent helper, den chief, and/or denner. Organize the space (seating, flags, advancement charts, activity materials, handouts, etc.). If you're snacking, organize space for that and the cleanup.

Gathering

- ▶ Have a gathering activity (games, puzzles, other) that will keep Scouts interested and busy and that others may join as they arrive. If the den desires, serve a healthy snack during this time.
- ▶ If you have background materials for the activity badge, Scouts may be interested in reviewing those.
- ▶ Collect dues, record attendance and any advancement completed at home (a good job for an assistant den leader). Assign parents to meeting roles and hand out a meeting plan to each.

Opening

- ▶ Flag ceremony (rotate planning and leadership among the Webelos Scouts), with Pledge; maybe recite the Cub Scout Promise or sing a patriotic song; perhaps add a roll call, uniform recognition, den yell. Webelos Scouts will eventually want to incorporate the Boy Scout Oath and Boy Scout Law into ceremonies.
- ▶ If you have a guest, give a formal introduction, including what the guest will do for you.

Business Items

- ▶ Use this time also to discuss participation in upcoming pack meetings or events as needed.
- ▶ **Verify:** Review boys' handbooks for completion of **Fitness 2–7**. Sign handbooks and record on the den advancement record.
- ▶ Explain that today's meeting is to work on the **Naturalist activity badge** because we all need to increase our awareness of, and gain an appreciation for, the natural world around us.

Activities

- ▶ **Naturalist Activity Badge:** Requirements are to do requirement 1 and then five of 2 through 13. (This meeting plan does 1, 4, 8, and 10. Requirements 6, 7, and 9 are to be covered in the next meeting.)
 1. With your parent, guardian, or Webelos den leader, complete the Respect Character Connection.
 - a. **Know:** Tell what interested you most when completing the requirements for this activity badge. Tell what you learned about how you can show appreciation and respect for wildlife.
 - b. **Commit:** Tell things some people have done that show a lack of respect for wildlife. Name ways you will show respect for and protect wildlife.
 - c. **Practice:** Explain how completing the requirements for this activity badge gives you the opportunity to show respect.



4. Visit a museum of natural history, a nature center, or a zoo with your family, Webelos den, or pack. Tell what you saw.
 8. Watch six wild animals (snakes, turtles, fish, birds, or mammals) in the wild. Describe the kind of place (forest, field, marsh, yard, or park) where you saw them. Tell what they were doing.
 10. Identify a plant, bird, or wild animal that is found only in your area of the country. Tell why it survives only in your area.
- **Forester Activity Badge:** Requirements are to do five of 1–10. This plan does requirements 3, 4, and 9.
3. Identify six forest trees common to the area where you live. Tell how both wildlife and humans use them. (If you don't live in a region that has forests, read about one type of forest and name six of its trees and their uses.)
 4. Identify six forest plants (other than trees) that are useful to wildlife. Tell which animals use them and for what purposes.
 9. Describe both the benefits and the harm wildfires can cause in a forest ecosystem. Tell how you can prevent wildfire.
- Activities you could do for these requirements include:
- Tree Survey:
 - Select a small area with several species of trees, like a school yard, a small park, or someone's yard.
 - Sketch a map of the area.
 - Divide the boys into pairs and assign each a section of the area.
 - Have them collect a leafy twig from each tree in their area and try to identify the species (if you can't identify it, describe it, and compare it to other known types of trees).
 - Measure the height and diameter of each tree.
 - Collect any fallen twigs, branches and leaves for leaf print and wood samples.
 - See how many different species were found.
 - Leaf Identification Contest (you might collect the supplies for this while on the hike and use for the pack):
 - Mount about 20 different leaves on a large piece of cardboard with each properly identified.
 - Also prepare another piece of cardboard with the same leaves in different locations.
 - Number these leaves but don't identify them.
 - Give the boys time to study the first display, and then put it away.
 - Give each boy paper and pencil and ask them to identify the leaves on the second display.
 - Find a Tree Game:
 - Play this game outdoors where there are plenty of trees.
 - Pair the boys with a partner and have one of them put on a blindfold.
 - The non-blindfolded boy leads his partner to a tree, who feels the tree's bark, limbs, and leaves.
 - The pair returns to their starting point.
 - The boy removes his blindfold and tries to find the tree he felt while blindfolded.
 - Then it is the other boy's turn to find a tree.
- In the boys' *Webelos Handbooks*, sign the requirements met (and update your records).

Closing

- Award (or recognize) any advancement completed today; thank hosts, guests, helpers.
- Closing ceremony (rotate planning and leadership to complete **Webelos requirement 6**): Retire the colors; maybe with the Boy Scout Oath and/or Law, or the Law of the Pack and/or den yell. Den leader may add a den leader's minute comment.
- Remind the Webelos Scout who will plan and lead the next meeting's flag ceremony, and remind about home assignments (and include these in any family information letter or e-mail).
- Hand out or send family information letter.

- **Home Assignment:** Review the Forester and Naturalist chapters of the *Webelos Handbook*.

Den Meeting 2



After the Meeting

- ▶ Re-read the Naturalist and Forester chapters in the *Webelos Handbook*.
- ▶ If you've changed the sequence of den meetings, double-check to make sure you will still advance your boys appropriately and check with the Cubmaster to make sure you stay coordinated with the pack.
- ▶ Refreshments: If appropriate
- ▶ Cleanup: Recruit enough help to do a good job. Scouts always leave an area as clean, or cleaner, than they found it.

Webelos Den Meeting 3

Naturalist Hike

Naturalist activity badge (completion). Webelos badge (partial).



Preparation and Materials Needed

- ▶ Den Meeting 3 continues and completes the Naturalist and Forester activity badges. Check that preparation for Den Meeting 2 has you ready for Den Meeting 3 as well.

Before the Meeting

- ▶ Review After the Meeting at the end of the previous den meeting plan for necessary preparation and materials.
- ▶ Make final preparations with assistance from any assistant den leader or other parent helper, den chief, and/or denner. Organize the space (seating, flags, advancement charts, activity materials, handouts, etc.). If you're snacking, organize space for that and the cleanup.

Gathering

- ▶ Have a gathering activity (games, puzzles, other) that will keep Scouts interested and busy and that others may join as they arrive. If the den desires, serve a healthy snack during this time.
- ▶ If you have background materials for the activity badge, Scouts may be interested in reviewing those.
- ▶ If you're on a field trip, as boys arrive, collect permission slips from parents who are not staying.
- ▶ Collect dues, record attendance and any advancement completed at home (a good job for an assistant den leader). Assign parents to meeting roles and hand out a meeting plan to each.

Opening

- ▶ Flag ceremony (rotate planning and leadership to complete **Webelos requirement 6**), with Pledge of Allegiance; maybe recite the Cub Scout Promise or sing a patriotic song; perhaps add a roll call, uniform recognition, or den yell.
- ▶ Since you're on a hike today, have the boys recite the Outdoor Code.
- ▶ If you have a guest, give a formal introduction, including what the guest will do for you.

Business Items

- ▶ Remind the boys of appropriate behavior, including safety considerations, at the site of your visit.
- ▶ Use this time also to discuss participation in upcoming pack meetings or events as needed.
- ▶ Explain that today's meeting is to complete work on the **Naturalist activity badge**.

Activities

- ▶ **Introduce Webelos Badge Requirements** before or during breaks on the hike:
 3. Know and explain the meaning of the Webelos badge.
 4. Point out the three special parts of the Webelos Scout uniform. Tell when to wear the uniform and when not to wear it.
 7. Show that you know and understand the requirements to be a Boy Scout.
 - a. Demonstrate the Scout salute, Scout sign, and Scout handshake. Explain when you would use them.
 - b. Explain the Scout Oath, Scout Law, Scout motto, and Scout slogan.
 - c. Explain and agree to follow the Outdoor Code.
 - **Hint:** Use Scout Oath Charades: Write out each of the following phrases of the Boy Scout Oath on an index card. Give one to each boy and have him act out what it says on the card (you may want to add hints on how to do this under the phrase). The other boys guess what line of the Scout Oath is being demonstrated.
 - On my honor, I will do my best . . . (*Show Boy Scout sign.*)
 - To do my duty to God and my country . . . (*Hold hands like praying, then salute.*)
 - And to obey the Scout Law. (*Count to 12 on fingers.*)
 - To help other people at all times . . . (*Get a chair for the leader and have him/her sit in it.*)
 - To keep myself physically strong . . . (*Do five jumping jacks.*)
 - Mentally awake . . . (*Pretend to read a book.*)
 - And morally straight. (*Stand at attention, with arms straight at side.*)



- ▶ **Naturalist Activity Badge:** Requirements 6, 7 and 9 (*Note: Show these items as much as possible, don't just talk about them.*):
 6. Learn about the bird flyways closest to your home. Find out which birds use these flyways.
 - Go outside to at least *look* for what birds are flying, even if you are not in a flyway!
 7. Learn to identify poisonous plants and venomous reptiles found in your area.
 - Can you find a poisonous plant in the vicinity of your meeting? Show it!
 - If you can't find one today, see if you can find one on the hike next meeting.
 9. Give examples of:
 - a. A producer, a consumer, and a decomposer in the food chain of an ecosystem
 - Take the Scouts outside to find producers, consumers and decomposers.
 - Have them look for evidence of each of these in the neighborhood location.
 - Especially decomposers! Lift any rock, find rotting leaves.
 - For decomposers, you might have an activity where the boys collect insects. Boys won't have any trouble finding insects in either the city or the country, but if they want a particular kind, you may be able to suggest where to look for it and how to catch it.
 - Beetles and crickets: Sink a small jar or can in the ground so that the rim is level with the surface. Pour in about an inch of a sweet mixture, such as two parts molasses and one part water. This gooey mess will attract hordes of insects, which will tumble into the jar and be trapped. They will drown in a short time, so check the trap frequently to catch a live one.
 - Butterflies, moths, and other flying insects: A sweet, slightly fermented pulp of fruits (peaches or apricots) painted on a tree trunk will trap flying insects. Or you can catch them with a net in an empty lot, open field, or public park.
 - Earthworms can often be found in a handful of soil. Clear away any surface debris from a small patch of ground. Force a soup can deep into the earth, scooping up as much soil as you can, and then empty it onto a sheet of paper (white is best). See how many earthworms and insects you have captured.
 - Here are some things the boys might watch for when observing insects:
 - Watch how ants work together to accomplish a task. Make a note of what they do, and which ants perform each of the various duties.
 - Does light or temperature have any effect on the speed of crawling insects?
 - Does the insect prefer one type of food to another? What does it like best?
 - Listen to music-making insects, such as grasshoppers, crickets, and katydids. How many chirps do they make in a minute? Does a temperature change affect the number of chirps per minute?
 - b. One way humans have changed the balance of nature
 - c. How you can help protect the balance of nature
 - You can quiz the Scouts on these two elements as you're looking for decomposing stuff.

Want More Fun Activities?

You might try this wormy experiment to show your den how worms work.

- ▶ Put four to five inches of rich soil in a large glass jar with a half-dozen earthworms.
- ▶ On top of the soil, put an inch of light sand. Sprinkle corn meal on the sand.
- ▶ Wrap black paper around the jar to shut out light. At your next den meeting, take off the paper and see what has happened.
- ▶ The worms will have moved dark soil up into the sand and sand down into the soil.
- ▶ You'll see tunnels along the glass marking their travels. Explain that the worms' tunnels help oxygenate the soil to nurture life and help the soil hold water.

- ▶ **Forester Activity Badge:** Requirements 5 and 6:
 5. Draw a picture showing
 - how water and minerals in the soil help a tree grow
 - how the tree uses sunlight to help it grow
 6. Make a poster showing a tree's growth rings or examine the growth rings of a tree stump. Explain how the rings tell its life history.
- ▶ In the boys' *Webelos Handbooks*, sign the requirements met (and update your records).



Closing

- ▶ Award (or recognize) any advancement completed today (ideally, award the activity badge or belt loop item completed today, and recognize later at the pack meeting); thank hosts, guests, helpers.
- ▶ Closing ceremony (rotate planning and leadership to complete **Webelos requirement 6**): Retire the colors; maybe with the Boy Scout Oath and/or Law, or the Law of the Pack and/or den yell. Den leader may add a den leader's minute comment.

▶ **Home Assignment:** Remind boys that **Athlete 4-7** requirements are due at the next meeting and to read the Travelers chapter in the *Webelos Handbook*.

- ▶ Remind the Webelos Scout who will plan and lead the next meeting's flag ceremony, and remind about home assignments (and include these in any family information letter or e-mail).
- ▶ Hand out or send family information letter.

After the Meeting

- ▶ If you've changed the sequence of den meetings, double-check to make sure you will still advance your boys appropriately and check with the Cubmaster to make sure you stay coordinated with the pack.
- ▶ Refreshments: If appropriate
- ▶ Cleanup: Recruit enough help to do a good job. Scouts always leave an area as clean, or cleaner, than they found it.



Webelos Den Meeting 4

Traveler and Athlete

Preparation and Materials Needed

- ▶ Materials checklist (add to your den Cub tub of U.S./den flags, paper/pencils, other supplies):
 - Several different kinds of maps (road maps for the local community, city or county, state; one or more world maps or globes; maybe other types of maps used in area destinations), ideally one for each Scout.
 - Obtain or print out maps and timetables from a railroad, bus line, airline, subway, or light rail (ideally, one of each for each Scout).
 - Pencils for drawing routes on the maps. Paper for drawing neighborhood maps.
 - Rulers or index cards (or thread) for measuring distances on the maps.
 - Ideally, access to a computer in order to review Internet maps and Internet direction searches.
 - **Traveler activity badges** and **Geography belt loops** for each of your Scouts (so they can be awarded if completed today).
- ▶ Read the Traveler chapter in the *Webelos Handbook*.
- ▶ Materials checklist (add to your den Cub tub of U.S./den flags, paper/pencils, other supplies):
 - Two copies of the same newspaper, two copies of the *Boy Scout Handbook*, and two pairs of scissors.
 - **Fitness activity badges**, **Traveler activity badges** and **Geography belt loops** for each of your Scouts (to be awarded if completed today).

Before the Meeting

- ▶ Review After the Meeting at the end of the previous den meeting plan for necessary preparation and materials.
- ▶ Make final preparations with assistance from any assistant den leader or other parent helper, den chief, and/or denner. Organize the space (seating, flags, advancement charts, activity materials, handouts, etc.). If you're snacking, organize space for that and the cleanup.

Gathering

- ▶ Have a gathering activity (games, puzzles, other) that will keep Scouts interested and busy and that others may join as they arrive. If the den desires, serve a healthy snack during this time.
- ▶ If you have background materials for the activity badge, Scouts may be interested in reviewing those.
- ▶ Collect dues, record attendance and any advancement completed at home (a good job for an assistant den leader). Assign parents to meeting roles and hand out a meeting plan to each.

Opening

- ▶ Flag ceremony (rotate planning and leadership to complete **Webelos requirement 6**), with Pledge of Allegiance; maybe recite the Cub Scout Promise or sing a patriotic song; perhaps add a roll call, uniform recognition, or den yell.
- ▶ If you have a guest, give a formal introduction, including what the guest will do for you.

Business Items

- ▶ Remind the boys of appropriate behavior, including safety considerations, at the site of your visit.
- ▶ Use this time also to discuss participation in upcoming pack meetings or events as needed.
- ▶ **Verify:** Check boys' handbooks for parent/guardian signatures for **Athlete 4–7**. Sign handbooks and record on den advancement record.

Activities

- ▶ **Traveler Activity Badge:** Requirements are to do five of 13 requirements. This meeting plan covers these five—9, 10, 12, 1, and 11—which can be covered today to complete the activity badge if you have no computer access, but you might skip one or more of these to use computers and/or take a trip instead (see below).

You could have the requirements done in stations run by each attending parent and den chief, so that without multiple maps, computers and so on, they rotate through each station.



9. Look at a map legend on a road map of your area. Learn what the symbols mean. Show your den members what you have learned.
 - This is selected as the first activity because it is so important and basic to the skills.
 - If you don't have one map for each Scout, allow Scouts to go from map to map; parents and den chiefs can work with the Scouts at the different stations.
 - You might assign Scouts to each pick three to five symbols and describe them to the den or small group.
10. On a road map of your area, find a place of interest, and draw two different routes between it and your home. Use the map legend to determine which route is shorter in miles.
 - Use rulers or index cards (or thread) for measuring distances on the maps.
 - For more fun, if you have computer access today, you could see how their routes and distances compared to those on Internet map services that map out directions.
12. While you are a Webelos Scout, earn the **Cub Scout Academics belt loop for Geography**: Complete these three requirements:
 1. Draw a map of your neighborhood. Show natural and manmade features. Include a key or legend of map symbols.
 2. Learn about the physical geography of your community. Identify the major landforms within 100 miles. Discuss with an adult what you learned.
 3. Use a world globe or map to locate the continents, the oceans, the equator, and the northern and southern hemispheres. Learn how longitude and latitude lines are used to locate a site.
 - Allow each Scout to show his neighborhood map and identify the legends on the map.
1. Get a map or timetable from a railroad, bus line, airline, subway, or light rail. The line should serve the place where you live or near where you live. Look up some places it goes.
 - Allow each to report on places the mass transit lines run.
11. Make a list of safety precautions you, as a traveler, should take for travel by each of the following; car, bus, plane, boat, train.
 - Allow each to provide their ideas, preferably in small groups.
 - You can then have the small groups decide on the best ideas to present to the den.

Options to Complete the Activity Badge

These could be done instead of one of the requirements above, or as additional activities:

3. With the help of your parent, guardian, teacher, or librarian, use a map site on the Internet to plan a trip from your home to a nearby place of interest. Download and/or print the directions and street map showing how to go from your home to the place you chose.
 - ▶ If you have one or more computers, this ties directly into No. 10.
 - ▶ If you have identified upcoming field trips or pack weekend activities, you should assign these destinations to the Scouts—so they can tell their parents how to get there!
4. With your parent or guardian, take a trip to a place that interests you. Go by car, bus, boat, train, or plane.
 - ▶ If you're doing a field trip in an upcoming meeting, you can use that to complete this requirement.
8. Check the first-aid kit in the family car to see if it contains what is needed. Explain what you found.
 - ▶ Ideally, have several of these. Have attending parents confirm what they are carrying.
 - ▶ Allow each to provide their ideas, preferably in small groups, and then report to the whole den.
6. Decide on four nearby trips you would like to take with your parents or guardian. Draw the route of each trip on a highway map. Using the map, act as navigator on one of these trips. It should start at your home, be at least 25 miles long, and have six or more turns.
 - ▶ This can be an interesting planning exercise, if you can have the Scouts consider destinations for a potential hike or campout or trip.
 - ▶ Perhaps assign different destinations to different Scouts to present to the group.

Den Meeting 4



Closing

- ▶ Award (or recognize) any advancement completed today; thank hosts, guests, helpers.
- ▶ Closing ceremony (rotate planning and leadership to complete **Webelos requirement 6**): Retire the colors; maybe with the Boy Scout Oath and/or Law, or the Law of the Pack and/or den yell. Den leader may add a den leader's minute comment.
- ▶ Remind the Webelos Scout who will plan and lead the next meeting's flag ceremony, and remind about home assignments (and include these in any family information letter or e-mail).
- ▶ Hand out or send family information letter.

▶ **Home Assignment:** Remind boys and their parent or guardian to begin working on Webelos requirement 8, Faith. This requirement takes some time and will need to be complete by Den Meeting 8. Boys should also review the Citizen chapter in their handbooks.

After the Meeting

- ▶ If you've changed the sequence of den meetings, double-check to make sure you will still advance your boys appropriately and check with the Cubmaster to make sure you stay coordinated with the pack.
- ▶ Refreshments: If appropriate
- ▶ Cleanup: Recruit enough help to do a good job. Scouts always leave an area as clean, or cleaner, than they found it.



Webelos Den Meeting 5

Webelos Citizens Introduction

Citizen activity badge (partial).

Preparation and Materials Needed

- ▶ Identify any parents or other pack resources who are interested in coordinating service projects, because they would be useful to have at this meeting as a service project is planned.
 - Be sure any guest speaker knows how long the presentation should run, and that you've confirmed what can or should be covered that would be interesting and fun for the Scouts.
- ▶ Read the Citizen chapter in the *Webelos Handbook*.
- ▶ Materials checklist (add to your den Cub tub of U.S./den flags, paper/pencils, other supplies):
 - Several U.S. flags so the Scouts can practice folding and care of the flags.
 - Poster board, markers, paper.

Service Project

Citizen requirement 8 and **Citizenship belt loop requirement 3** are to participate in a family, den, or school service project. This requires planning and discussion with the boys and can take some time. Develop a plan to begin with Den Meeting 5.

Before the Meeting

- ▶ Review After the Meeting at the end of the previous den meeting plan for necessary preparation and materials.
- ▶ Make final preparations with assistance from any assistant den leader or other parent helper, den chief, and/or denner. Organize the space (seating, flags, advancement charts, activity materials, handouts, etc.). If you're snacking, organize space for that and the cleanup.

Gathering

- ▶ Have a gathering activity (games, puzzles, other) that will keep Scouts interested and busy and that others may join as they arrive. If the den desires, serve a healthy snack during this time.
- ▶ If you have background materials for the activity badge, Scouts may be interested in reviewing those.
- ▶ Collect dues, record attendance and any advancement completed at home (a good job for an assistant den leader). Assign parents to meeting roles and hand out a meeting plan to each.

Opening

- ▶ Flag ceremony (rotate planning and leadership to complete **Webelos requirement 6**), with Pledge of Allegiance; maybe recite the Cub Scout Promise or sing a patriotic song; perhaps add a roll call, uniform recognition, or den yell.
- ▶ If you have a guest, give a formal introduction, including what the guest will do for you.

Business Items

- ▶ Use this time to discuss participation in upcoming pack meetings or events as needed.
- ▶ Explain that today's meeting is to work on the **Citizen activity badge**, one of the badges required for the Webelos badge, because of the importance of recognizing our rights and responsibilities as citizens.

Activities

- ▶ **Citizen Activity Badge:** Requirements are to do requirements 1 through 8, and then two of 9 through 17 (This meeting plan covers 1, 3, and 8. Other elements are covered in succeeding meetings.):
 1. With your parent, guardian, or Webelos den leader, complete the Citizenship Character Connection.
 - a. **Know:** List some of your rights as a citizen of the United States of America. Tell ways you can show respect for the rights of others.
 - b. **Commit:** Name some ways a boy your age can be a good citizen. Tell how you plan to be a good citizen and how you plan to influence others to be good citizens.
 - c. **Practice:** Choose one of the requirements for this activity badge that helps you be a good citizen. Complete the requirement and tell why completing it helped you be a good citizen.
 - Doing this in small groups helps allow each Scout to participate more fully.



- You might tie this into the den’s code of conduct, (or create a den code of conduct now if you don’t have one). As members of your den, they are also “citizens” of the den. The den leader can lead the Scouts to note how they can be good citizens in the den.
 - Rights and duties of citizens include these (also refer to the *Webelos Handbook*; several of these rights and duties don’t apply to people until they are adults. Stress those that are applicable to Webelos Scouts.):
 - The right to equal protection under the law and equal justice in the courts
 - The right to own property
 - The right to be free from arbitrary search or arrest
 - The right of free speech, press, and assembly
 - The right to equal education and economic opportunity
 - The right of religious freedom
 - The right to choose public officials in free elections
 - The right to have legal counsel of your choice
 - The duty to obey the laws
 - The duty to respect the rights of others
 - The duty to be informed on issues of government and community welfare
 - The duty to serve on juries, if called
 - The duty to vote in elections
 - The duty to serve and defend our country
 - The duty to assist agencies of law enforcement
 - The duty to practice and teach principles of good citizenship in the home
3. Describe the flag of the United States and give a short history of it. With another Webelos Scout helping you, show how to hoist and lower the flag, how to hang it horizontally and vertically on a wall, and how to fold it. Tell how to retire a worn or tattered flag properly.
- For the history of the U.S. flag, here is a quiz to help boys learn some of the history of our flag. After they have had an opportunity to discuss and study the questions and their answers, ask them the questions and let them answer either orally or in writing (you might divide the den into teams, quiz show style):
 - The flags of which five countries flew over our country (or parts of it) before it became the United States of America? (*Spain, France, Holland, Sweden, and England*)
 - What was the English flag of the 13 colonies called? (*The Queen Anne flag*)
 - When the colonists decided on a flag of their own, what did they call it? (*The Grand Union flag*)
 - How did the Grand Union flag differ from the Queen Anne flag? (*It had 13 stripes of red and white.*)
 - What was the name of the flag made after the Declaration of Independence? (*Old Glory*)
 - How did Old Glory differ from the Grand Union flag? (*The union was blue with 13 white stars instead of the crosses of St. George and St. Andrew.*)
 - What is the largest number of stripes the U.S. flag has ever had? When and why? (*The U.S. flag had 15 stripes during the War of 1812, because two new states had been added.*)
 - Why was the flag changed back to 13 stripes? (*Because it began to lose its symmetry and beauty.*)
8. As a Webelos Scout, earn the **Cub Scout Academics belt loop for Citizenship**. Complete these three requirements:
1. Develop a list of jobs you can do around the home. Chart your progress for one week.
 - For **belt loop requirement 1**, distribute the attached family job chart.
 - If you have time, you can start to have the Scouts complete that, and share ideas about what jobs they do at home, and why sharing the responsibility is the right thing as a citizen.
 2. Make a poster showing things that you can do to be a good citizen.
 3. Participate in a family, den, or school service project.
 - For **belt loop requirement 3**, discuss with the Webelos Scouts a service project you could conduct.
 - You could approach it completely openly, and solicit ideas just from the Webelos Scouts.
 - Or you might seed the discussion with ideas that you and other parents have.

Den Meeting 5



- If your project is to donate canned and nonperishable food items to a local food bank, they might collect and bring those to the next den meeting.
- You may have a different service project; perhaps collecting toys, books or clothing, and donating them to shelters or agencies; perhaps an anti-litter cleanup campaign. Use the resources of your parents and community and the ideas of your Scouts.
- You might have the Scouts promote the project by making posters for it (and expand the food items collection to schools and/or other institutions).
- With all of the flag work, this service project poster planning may not get completed here, and may need to carry over to one of the following meetings.
- If the next meeting will not have a community leader visit, you can definitely use that meeting for service project planning and poster making.

Want More Fun Activities?

Having done or started Webelos I Den Meeting 4 (“Athletes Practice Fitness”), you will have a good, active, physical activity to insert in this meeting (which has more talk and research, and a need for physical action).

- ▶ You can add Athlete progress chart activities into this meeting at various points.
- ▶ Those activities are curl-ups, pull-ups, push-ups, standing long jump, quarter-mile walk or run, vertical jump, and 50-yard dash
- ▶ Taking a break to check on *just one* of those can be a good active break in your meeting.

- ▶ In the boys’ *Webelos Handbooks*, sign the requirements met (and update your records).

Closing

- ▶ Award (or recognize) any advancement completed today; thank hosts, guests, helpers.
- ▶ Closing ceremony (rotate planning and leadership to complete **Webelos requirement 6**): Retire the colors; maybe with the Boy Scout Oath and/or Law, or the Law of the Pack and/or den yell. Den leader may add a den leader’s minute comment.
- ▶ Remind the Webelos Scout who will plan and lead the next meeting’s flag ceremony, and remind about home assignments (and include these in any family information letter or e-mail).

- ▶ **Home Assignment: Citizenship belt loop requirement 1:** Develop a list of jobs you can do around the home. Chart your progress for one week. (Webelos Scouts should return their completed job charts at the next meeting.) Continue to review the Citizen chapter in the handbook.

- ▶ Hand out or send family information letter.

After the Meeting

- ▶ If you’ve changed the sequence of den meetings, double-check to make sure you will still advance your boys appropriately and check with the Cubmaster to make sure you stay coordinated with the pack.
- ▶ Refreshments: If appropriate
- ▶ Cleanup: Recruit enough help to do a good job. Scouts always leave an area as clean, or cleaner, than they found it.



Webeelos Citizenship Belt Loop, Requirement 1

Develop a list of jobs you can do around the home.

Chart your progress for one week.

On this chart, list the jobs that you will do at home every day.

- Chart your progress as you do these for a week.

Name: _____

Day Job					
Sunday					
Monday					
Tuesday					
Wednesday					
Thursday					
Friday					
Saturday					



Webelos Den Meeting 6

Citizen

Preparation and Materials Needed

- ▶ Make arrangements to visit a community leader at his/her place of work. Discuss the requirements with the leader in advance. Make travel arrangements as needed and arrange permission slips.

Before the Meeting

- ▶ Review After the Meeting at the end of the previous den meeting plan for necessary preparation and materials.
- ▶ Make final preparations with assistance from any assistant den leader or other parent helper, den chief, and/or denner. Organize the space (seating, flags, advancement charts, activity materials, handouts, etc.). If you're snacking, organize space for that and the cleanup.

Gathering

- ▶ Have a gathering activity (games, puzzles, other) that will keep Scouts interested and busy and that others may join as they arrive. If the den desires, serve a healthy snack during this time.
- ▶ If you have background materials for the activity badge, Scouts may be interested in reviewing those.
- ▶ If you're on a field trip, as boys arrive, collect permission slips from parents who are not staying.
- ▶ Collect dues, record attendance and any advancement completed at home (a good job for an assistant den leader). Assign parents to meeting roles and hand out a meeting plan to each.

Opening

- ▶ Flag ceremony (rotate planning and leadership to complete **Webelos requirement 6**), with Pledge of Allegiance; maybe recite the Cub Scout Promise or sing a patriotic song; perhaps add a roll call, uniform recognition, or den yell.
- ▶ If you have a guest, give a formal introduction, including what the guest will do for you.

Business Items

- ▶ Remind the boys of appropriate behavior, including safety considerations, at the site of your visit.
- ▶ Use this time also to discuss participation in upcoming pack meetings or events as needed.
- ▶ **Verify:** Check boys' handbooks for parent/guardian signatures for **Citizen activity badge requirement 8/Citizenship belt loop 9 and 3**. Sign handbooks and record on den advancement record.

Activities

- ▶ **Traveler:** If any of the Scouts plotted the directions to today's field trip, you should ask them how the directions worked, and whether they and their parents were able to follow them.
- ▶ **Citizen Activity Badge:** Requirements 10, 8:
 10. With your Webelos den or your family, visit a community leader. (Visit the community leader at his or her place of work.) Learn about the duties of the job or office and tell what you have learned.
 - Most Webelos Scout-age boys have no contact with local government and little understanding of it.
 - By taking a field trip or having a visit, you can help them get an idea of how government operates and provides services to citizens.
 8. As a Webelos Scout, earn the **Cub Scout Academics belt loop for Citizenship**. Requirement is to participate in a family, den, or school service project.
- ▶ An element of the Citizen activity badge that has likely carried over from the last meeting is the service project planning as part of the **Cub Scout Academics belt loop for Citizenship**. You might see if the community leader is willing to hear from the Scouts about what their plan is for the service project, and if the community leader can offer encouragement (maybe even suggestions to them about how to get it done).
- ▶ If you don't have a community leader visit, you can definitely use this meeting for service project planning and poster making.



Other Ways to Complete the Activity Badge

If you don't have a community leader visit, you will want to cover one of the other Citizen requirements. (If you do have a community leader visit, some of these might be good questions to cover with the leader visit. You might ask the leader to be ready to discuss these with the den.) Options include:

9. Tell about two things you can do that will help law enforcement agencies.
11. Write a short story of not less than 50 words about a former U.S. president or some other great American. Give a report on this to your Webelos den.
12. Tell about another boy you think is a good citizen. Tell what he does that makes you think he is a good citizen.
13. List the names of three people you think are good citizens. (They can be from any country.) Tell why you chose each of them.
14. Tell why we have laws. Tell why you think it is important to obey the law. Tell about three laws you obeyed this week.
15. Tell why we have government. Explain some ways your family helps pay for government.
16. List four ways in which your country helps or works with other nations.
17. Name three organizations, not churches or other religious organizations, in your area that help people. Tell something about what one of these organizations does.

- ▶ **Webelos Badge Requirements:** Review (if you have a guest, you can have the Scouts explain these to the guest):

3. Know and explain the meaning of the Webelos badge.
4. Point out the three special parts of the Webelos Scout uniform. Tell when to wear the uniform and when not to wear it.
7. Show that you know and understand the requirements to be a Boy Scout.
 - a. Demonstrate the Scout salute, Scout sign, and Scout handshake. Explain when you would use them.
 - b. Explain the Scout Oath, Scout Law, Scout motto, and Scout slogan.
 - c. Explain and agree to follow the Outdoor Code.
 - These elements can be challenging to make fun, but fun options do exist, such as:
 - Roll the Dice Game—This requires one dice (a big one if you have it). Each boy rolls the dice and depending on what number comes up, he performs one of the Boy Scout requirements. Score points for each boy who does the task correctly. Here are possible tasks for each number:
 - 1 = Read or recite the Scout Oath and tell what it means.
 - 2 = Read or recite the Scout Law and tell what it means.
 - 3 = Recite the Scout motto and tell what it means.
 - 4 = Read or recite the Outdoor Code and tell its meaning.
 - 5 = Show the Scout handshake and tell its meaning.
 - 6 = Show the Scout salute and tell its meaning.
 - An alternate Roll the Dice game could be done with just the Scout Law (1 = Trustworthy, 2 = Loyal, etc.), but divided into two segments: first points 1 to 6 and then 7 to 12. That way, there is an even chance of each point of the Scout Law coming up!): Roll the die, and tell what the corresponding point of the Scout Law means to you.

- ▶ In the boys' *Webelos Handbooks*, sign the requirements met (and update your records).

Closing

- ▶ Award (or recognize) any advancement completed today; thank hosts, guests, helpers.
- ▶ Closing ceremony (rotate planning and leadership to complete **Webelos requirement 6**): Retire the colors; maybe with the Boy Scout Oath and/or Law, or the Law of the Pack and/or den yell. Den leader may add a den leader's minute comment.
- ▶ Hand out or send family information letter.

- ▶ **Home Assignment:** Review the Citizen chapter in the *Webelos Handbook*.

Den Meeting 6



After the Meeting

- ▶ If you've changed the sequence of den meetings, double-check to make sure you will still advance your boys appropriately and check with the Cubmaster to make sure you stay coordinated with the pack.
- ▶ Refreshments: If appropriate
- ▶ Cleanup: Recruit enough help to do a good job. Scouts always leave an area as clean, or cleaner, than they found it.



Webelos Den Meeting 7

Citizen

Preparation and Materials Needed

- ▶ The concept of Den Meeting 7 is to ask questions and complete (or get close to completion) on a lot of the details in the **Citizen badge**. To do this:
 - You might do an Internet search of Webelos and the name of a favorite game show (perhaps the one where there are categories, and the answer must be in the form of a question). This can be done as teams by splitting the den, or as individuals, perhaps done in tournament style to identify a den Citizen quiz champion.
 - Other alternatives include doing this in a quiz show style, splitting the den into two teams, and requiring the team to ring a bell to have the right to answer, and allowing some huddling to confirm the right answer before giving the other team a chance.
 - You might conduct this, or part of it, as “Are You Smarter Than a Webelos Scout?”—perhaps pitting Scouts against the den leader.
 - You will need to recruit one or more judges to determine scoring (you’ll need to inform the judges of the scoring rules if you’re using a game that does not supply that). Judges will need to use discretion (knowing the test is for the Scouts to “Do Their Best”) in determining scores.
- ▶ Materials checklist (add to your den Cub tub of U.S./den flags, paper/pencils, other supplies):
 - Supplies to promote this as a scholar quiz or game show.
 - If you have access to computer projection (either a big screen or a projector or smartboard), you might do some of this meeting using the resources you’ve checked out.
 - You might need to bring your own game boards, poster boards, cards, or other props.
 - A bell or other noisemaker for every team or contestant that might be playing at once. You may decide to just alternate first shots at answers.

Before the Meeting

- ▶ Review After the Meeting at the end of the previous den meeting plan for necessary preparation and materials.
- ▶ Make final preparations with assistance from any assistant den leader or other parent helper, den chief, and/or denner. Organize the space (seating, flags, advancement charts, activity materials, handouts, etc.). If you’re snacking, organize space for that and the cleanup.

Gathering

- ▶ Have a gathering activity (games, puzzles, other) that will keep Scouts interested and busy and that others may join as they arrive. If the den desires, serve a healthy snack during this time.
- ▶ If you have background materials for the activity badge, Scouts may be interested in reviewing those.
- ▶ Collect dues, record attendance and any advancement completed at home (a good job for an assistant den leader). Assign parents to meeting roles and hand out a meeting plan to each.

Opening

- ▶ Flag ceremony (rotate planning and leadership to complete **Webelos requirement 6**), with Pledge of Allegiance; maybe recite the Cub Scout Promise or sing a patriotic song; perhaps add a roll call, uniform recognition, or den yell.
- ▶ If you have a guest, give a formal introduction, including what the guest will do for you.

Business Items

- ▶ Use this time also to discuss participation in upcoming pack meetings or events as needed.
- ▶ Explain that today’s meeting is to continue work on the **Citizen activity badge** and how you’ll do it.

Activities

- ▶ **Citizen Activity Badge Requirements:**
 2. Know the names of the president and vice president of the United States, elected governor of your state, and the head of your local government.
 3. Describe the flag of the United States and give a short history of it. Tell how to retire a worn or tattered flag properly.



4. Explain why you should respect your country's flag. Tell some of the special days we fly it. Tell when to salute the flag and show how to do it.
 5. Repeat the Pledge of Allegiance from memory. Explain its meaning in your own words.
 6. Tell how our national anthem was written.
 7. Explain the rights and duties of a citizen of the United States. Explain what a citizen should do to save our natural resources.
 9. Tell about two things you can do that will help law enforcement agencies.
- ▶ Examples of game show questions are provided at the end of this meeting plan.
 - ▶ In the boys' *Webelos Handbooks*, sign the requirements met (and update your records).

Closing

- ▶ Award (or recognize) any advancement completed today; thank hosts, guests, helpers.
- ▶ Closing ceremony (rotate planning and leadership to complete **Webelos requirement 6**): Retire the colors; maybe with the Boy Scout Oath and/or Law, or the Law of the Pack and/or den yell. Den leader may add a den leader's minute comment.
- ▶ Remind the Webelos Scout who will plan and lead the next meeting's flag ceremony, and remind about home assignments (and include these in any family information letter or e-mail):

▶ **Home Assignment:** Remind boys and parents that they need to complete **Webelos badge requirement 8** at home and it is due at the next meeting. See page 50 of the *Webelos Handbook*. Review the Artist chapter in the handbook.

- The next meeting is designed to wrap up the **Citizen activity badge**.
- ▶ Hand out or send family information letter.

After the Meeting

- ▶ If you've changed the sequence of den meetings, double-check to make sure you will still advance your boys appropriately and check with the Cubmaster to make sure you stay coordinated with the pack.
- ▶ Refreshments: If appropriate
- ▶ Cleanup: Recruit enough help to do a good job. Scouts always leave an area as clean, or cleaner, than they found it.



National Anthem	People in Government	American Flag Etiquette	America's Symbols	Pledge of Allegiance
The Star-Spangled Banner is also called this.	He was our first president.	The flag should not be allowed to touch this.	The home of the president is called this.	When Americans say the Pledge of Allegiance, we put our hand over this.
What is our national anthem?	Who was George Washington?	What is the ground?	What is the White House?	What is our heart?
He wrote the Star-Spangled Banner.	He/she is our current president.	If you are a Scout, you use the Scout salute to salute the flag only when this.	The Declaration of Independence says that all men are created this.	The word PLEDGE means this.
Who was Francis Scott Key?	Who is _____?	What is when in uniform?	What is equal?	What is a promise?
Before it was a song, the Star-Spangled Banner was this.	He/she is our current vice president.	When the flag is folded properly, it is this shape.	The left hand of the Statue of Liberty holds this.	The word INDIVISIBLE means this.
What is a poem?	Who is _____?	What is a triangle?	What is a tablet?	What is "can't be taken apart"?
The Star-Spangled Banner was written while on this.	He/she is the governor of the state of _____.	The flag is always placed on this side of a speaker.	The presidential airplane is called this.	These two words were added to the pledge in the 1950s.
What is a ship?	Who is _____?	What is the right?	What is Air Force One?	What are "under God"?
According to the song, that Star-Spangled Banner yet waves over this.	He/she is the chief executive officer of _____ County (or the city of _____).	The flag is flown this way in times of distress.	He wears a tall striped hat.	The word ALLEGIANCE means this.
What is "the land of the free, and the home of the brave"?	Who is _____?	What is upside down?	Who is Uncle Sam?	What is loyal?

American Flag History	Respecting the Flag	Fun State Names	Your Rights and Duties	Odds and Ends
She is said to have sewn the first flag. Who is Betsy Ross?	You do this when the flag is hoisted or lowered. What is saluting the flag?	This state name has an island. What is Rhode Island?	This allows you to pray as you see fit. What is the right to worship?	The activity badge we are working on. What is Citizen?
These represent the 50 states. What are the stars?	When not in uniform, you do this when reciting the Pledge of Allegiance. What is placing your hand over your heart?	This state name has an Indian. What is Indiana?	This allows you to say what you think. What is freedom of speech?	The capital of our state. What is _____?
These represent the 13 original states. What are the stripes of the flag?	A day in September the flag should fly. What is Labor Day?	This state name has a ton. What is Washington?	This allows adults to choose the members of our government. What is the right to vote?	This capital is not in a state. What is Washington, D.C.?
This is Flag Day. What is June 14?	A day in November the flag should fly. What is Veteran's Day or Thanksgiving Day?	This state name is cut on the end. What is Connecticut?	This allows you to create groups of people to discuss problems. What is the right to assemble?	A day in January the flag should fly. What is New Year's Day, Inauguration Day, or Martin Luther King Jr. Day?
Before the American flag, most of the American colonies used this kind of flag for about 150 years. What is the British flag?	We do this to dispose of an old, worn-out flag. What is burn it?	This state name has a tuck in the middle. What is Kentucky?	This paper is required before anyone—police included—can search your home. What is a warrant?	By saying this, you promise loyalty and devotion to your nation. What is the Pledge of Allegiance?





Webelos Den Meeting 8

Webelos Citizen and Fitness Completion

Citizen activity badge (completion). Artist activity badge (partial). Webelos badge (complete, subject to three-month membership).

Preparation and Materials Needed

- ▶ This meeting is designed to wrap up the **Citizen activity badge**, a requirement for the Webelos badge of rank, so:
 - Review each boy's status in your den advancement record.
 - Develop a plan with you assistant den leader and parents to close any gaps during the next den meeting.
- ▶ Read the Artist chapter in the *Webelos Handbook*.
- ▶ Identify any parents or other pack resources who are artists and could be your activity badge counselor for this meeting. An artist may be an art teacher or anyone who has talent in drawing, painting, sculpting, animation, cartooning, pottery, or crafts. See if the artist can visit your den meeting, or do a field trip to the artist's studio or classroom.
 - Be sure any guest speaker knows how long the presentation should run, and that you've confirmed what can or should be covered that would be interesting and fun for the Scouts.
 - Show them the Artist chapter in the *Webelos Handbook*.
- ▶ If you are doing this as a field trip, inform Scouts and families about when and where to meet.
- ▶ Materials checklist (add to your den Cub tub of U.S./den flags, paper/pencils, other supplies):
 - Red, yellow, and blue paints (for more fun, you might also bring red, yellow, and blue frosting).
 - Paper; paintbrushes. Clay or air-drying modeling material.
 - Flag-sized fabric; and any other elements you determine you want the Scouts to create.
 - Towels, soap, and water for cleanup.

Before the Meeting

- ▶ Review After the Meeting at the end of the previous den meeting plan for necessary preparation and materials.
- ▶ Make final preparations with assistance from any assistant den leader or other parent helper, den chief, and/or denner. Organize the space (seating, flags, advancement charts, activity materials, handouts, etc.). If you're snacking, organize space for that and the cleanup.

Gathering

- ▶ Have a gathering activity (games, puzzles, other) that will keep Scouts interested and busy and that others may join as they arrive. If the den desires, serve a healthy snack during this time.
- ▶ If you have background materials for the activity badge, Scouts may be interested in reviewing those.
- ▶ Collect dues, record attendance and any advancement completed at home (a good job for an assistant den leader). Assign parents to meeting roles and hand out a meeting plan to each.

Opening

- ▶ Flag ceremony (rotate planning and leadership to complete **Webelos requirement 6**), with Pledge of Allegiance; maybe recite the Cub Scout Promise or sing a patriotic song; perhaps add a roll call, uniform recognition, or den yell.
- ▶ If you have a guest, give a formal introduction, including what the guest will do for you.

Business Items

- ▶ Use this time also to discuss participation in upcoming pack meetings or events as needed.
- ▶ Explain that today's meeting is to complete work on the **Citizen and Fitness activity badges**.
- ▶ **Verify:** Check boys' handbooks for parent/guardian signatures for **Webelos requirement 8** and sign handbooks and record on den advancement record.

Activities

- ▶ **Complete Citizen Activity Badge Requirements**—to the extent that anyone in the past meetings has not been signed off on the elements that your den worked on in the den meetings:
 1. With your parent, guardian, or Webelos den leader, complete the Citizenship Character Connection.



- a. **Know:** List some of your rights as a citizen of the United States of America. Tell ways you can show respect for the rights of others.
 - b. **Commit:** Name some ways a boy your age can be a good citizen. Tell how you plan to be a good citizen and how you plan to influence others to be good citizens.
 - c. **Practice:** Choose one of the requirements for this activity badge that helps you be a good citizen. Complete the requirement and tell why completing it helped you be a good citizen.
2. Know the names of the president and vice president of the United States, elected governor of your state, and the head of your local government.
 3. Describe the flag of the United States and give a short history of it. With another Webelos Scout helping you, show how to hoist and lower the flag, how to hang it horizontally and vertically on a wall, and how to fold it. Tell how to retire a worn or tattered flag properly.
 4. Explain why you should respect your country's flag. Tell some of the special days we fly it. Tell when to salute the flag and show how to do it.
 5. Repeat the Pledge of Allegiance from memory. Explain its meaning in your own words.
 6. Tell how our national anthem was written.
 7. Explain the rights and duties of a citizen of the United States. Explain what a citizen should do to save our natural resources.
 9. Tell about two things you can do that will help law enforcement agencies.
 10. With your Webelos den or your family, visit a community leader. Learn about the duties of the job or office and tell what you have learned.
 - Complete service project (collection of items or other activity—depends on den plans).
 - Or review results of service project if completed outside of the meeting.
 - If you did not do a community leader visit, or a Scout was absent from this, requirement 12 is a good replacement: Tell about another boy you think is a good citizen. Tell what he does that makes you think he is a good citizen.
- **Review Webelos Badge Requirements** (pages 49 and 50 of the *Webelos Handbook*), consult den records, verify completion, and review as necessary.
- **Artist Activity Badge:** Requirements are to do the first two requirements, and then five of 3 through 11 (This meeting plan does the 1, 4, 7, and 9 as shown below, and 2, 8, and 10 are done in the Den Meeting 15.):
1. Talk to an artist in your area or to your art teacher about the different occupations in the art field. Make a list of them.
 - Encourage the artist to take ideas from the boys, to lead them to discover the many art-related jobs.
 4. List the primary and secondary colors. Explain what happens when you combine colors.
 - Study a color wheel and practice mixing paints to make shades and tints (see *Webelos Handbook*).
 - Maybe have each boy prepare a color scheme for his room.
 - Color palette: You can make a palette for each boy out of heavy cardstock. See the example.

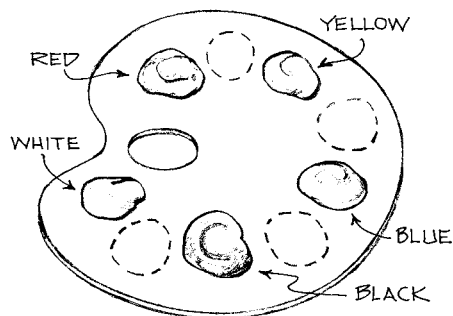

- Let them fill in the primary colors with acrylic, tempera, or poster paint; then mix the primary colors to see what secondary colors result.
- For more fun, use colored frosting. Buy or prepare colored frosting and let boys mix colors to decorate cookies.

Den Meeting 8



7. Use clay to sculpt a simple object.
 - Could be a simple clay sculpture of whatever figure the Scout imagines.
- For more fun, make an arrowhead neckerchief slide:
 - Sculpt the arrowhead in clay, about 2 inches high by 2 inches wide.
 - For the slide device, cut a slice from PVC pipe using a hacksaw; file or sand the edges smooth.
 - Press the piece of PVC pipe into the back of the clay slide. Given Cub Scout wear and tear, you may need to add some other fasteners, like wire, to run into and through the clay.
 - When the clay is dry, paint it brown or dull gold. Add your pack number or other decorations as you like. You can start this today, and complete it in the next meeting.

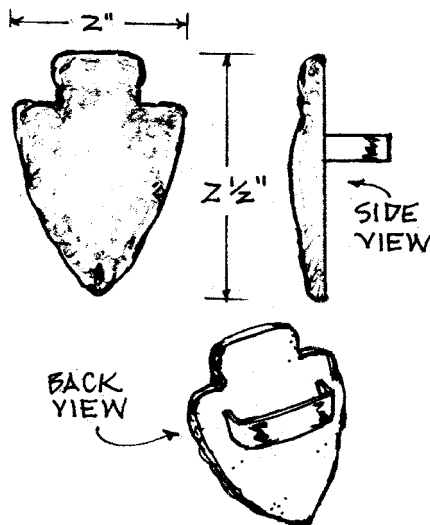

9. Make an art construction, using your choice of materials.
 - Could be sand painting.
 - Many American Indian tribes have practiced sand painting for generations, so boys may want to try an Indian design or scene. Beach sand or any fine sand that has been rinsed with fresh water and a little bleach works best. Color the sand with food coloring or tempera paint, using small amounts until the desired shade is reached. Let the painted sand dry.
 - Draw the design on cardboard, indicating the colors to be used. Cover one color area at a time with white glue. Spoon the sand onto the glued surface. Let it set briefly, gently shake off any excess sand, and then move on to the next color area. A large area should be done in several pourings. The sand painting can be framed, if desired.
 - Or salt painting (easier than sand painting):
 - Pour salt on paper. Roll a piece of colored chalk over the salt; The chalk will become powdered and mix with the salt to color it. Prepare several different colors of salt.
 - Have boys spoon layers of differently colored salt on top of each other in a small jar. Fill the jar to the top. Then insert a piece of wire (opened paper clips work well) down the side of the jar against the glass, pushing through the layers of salt, to form designs. Fill the jar to the very top with additional salt, if needed, and seal it.
 - Could be earthquake art:
 - Draw or paint a picture in the medium of your choice. Then cut the picture apart into unusual shapes. Put the pieces of the picture back together on a piece of colored construction paper or poster board as you would a jigsaw puzzle, but leave spaces between each piece, allowing the color of the background paper to show through.
 - Paste the picture pieces to the background. It will look like it's been in an earthquake!



Other Ways to Complete the Activity Badge

Optional **Artist activity badge requirements (Requirements 2, 8, and 10)** are done in the next meeting.):

3. Draw or paint an original picture out-of-doors, using the art materials you prefer. Frame the picture for your room or home.
5. Using a computer, make six original designs using straight lines, curved lines, or both.
 - If you have good software and knowledge of this, you might want to do this instead.
6. Draw a profile of a member of your family.
 - Especially if you do a complicated clay artwork, and are short of time, this could be done instead of number 9, "make an art construction, using your choice of materials."
11. While a Webelos Scout, earn the **Cub Scout Academics belt loop for Art**; requirements:
 1. Make a list of common materials used to create visual art compositions.
 2. Demonstrate how six of the following elements of design are used in a drawing: lines, circles, dots, shapes, colors, patterns, textures, space, balance, or perspective.
 3. Identify the three primary colors and the three secondary colors that can be made by mixing them. Show how this is done using paints or markers. Use the primary and secondary colors to create a painting.

- ▶ In the boys' *Webelos Handbooks*, sign the requirements met (and update your records).

Closing

- ▶ Award (or recognize) any advancement completed today (ideally, award the activity badge or belt loop item completed today, and recognize later at the pack meeting); thank hosts, guests, helpers.
- ▶ Closing ceremony (rotate planning and leadership to complete **Webelos requirement 6**): Retire the colors; maybe with the Boy Scout Oath and/or Law, or the Law of the Pack and/or den yell. Den leader may add a den leader's minute comment.
- ▶ Remind the Webelos Scout who will plan and lead the next meeting's flag ceremony, and remind about home assignments (and include these in any family information letter or e-mail).
- ▶ Hand out or send family information letter.

- ▶ **Home Assignment:** Review the Geologist chapter in the *Webelos Handbook*.

After the Meeting

- ▶ If you've changed the sequence of den meetings, double-check to make sure you will still advance your boys appropriately and check with the Cubmaster to make sure you stay coordinated with the pack.
- ▶ Refreshments: If appropriate
- ▶ Cleanup: Recruit enough help to do a good job. Scouts always leave an area as clean, or cleaner, than they found it.

Den Meeting 9



This meeting is outlined as a field trip. Are you prepared?

Alternate approaches are possible. See the plan.

Webelos Den Meeting 9

Geologist

Preparation and Materials Needed

- ▶ Read the Geologist chapter in the *Webelos Handbook*.
- ▶ Make arrangements for a field trip to a landscaping contractor, stone quarry, concrete plant, geological site, geological laboratory, rock show, or rock shop. Arrange for drivers. This is the most interesting plan, but you can still complete the achievement using other requirements noted below. Identify any parents or other pack resources who are geologists or rock collectors and could be an activity badge counselor for this meeting.
 - Be sure any guest speaker knows how long the presentation should run, and that you've confirmed what can or should be covered that would be interesting and fun for the Scouts.
 - Show any guest speaker the Geologist chapter in the *Webelos Handbook*.
 - If you don't do this as a field trip, take a hard look at this meeting and the next, and determine how to make it fun and interesting, and how to allocate the requirements.
 - Getting a visitor to bring a rock and mineral collection is a terrific idea.
- ▶ If you are doing this as a field trip, inform Scouts and families about when and where to meet.
- ▶ Materials checklist (add to your den Cub tub of U.S./den flags, paper/pencils, other supplies):
 - Rock collections, books.
 - Plastic zipper bags, labeled with each boy's name, for each to collect his specimens.

Before the Meeting

- ▶ Review After the Meeting at the end of the previous den meeting plan for necessary preparation and materials.
- ▶ Make final preparations with assistance from any assistant den leader or other parent helper, den chief, and/or denner. Organize the space (seating, flags, advancement charts, activity materials, handouts, etc.). If you're snacking, organize space for that and the cleanup.

Gathering

- ▶ Have a gathering activity (games, puzzles, other) that will keep Scouts interested and busy and that others may join as they arrive. If the den desires, serve a healthy snack during this time.
- ▶ If you have background materials for the activity badge, Scouts may be interested in reviewing those.
- ▶ If you're on a field trip, as boys arrive, collect permission slips from parents who are not staying.
- ▶ Collect dues, record attendance and any advancement completed at home (a good job for an assistant den leader). Assign parents to meeting roles and hand out a meeting plan to each.

Opening

- ▶ Flag ceremony (rotate planning and leadership to complete **Webelos requirement 6**), with Pledge of Allegiance; maybe recite the Cub Scout Promise or sing a patriotic song; perhaps add a roll call, uniform recognition, or den yell.
- ▶ If you have a guest, give a formal introduction, including what the guest will do for you.

Business Items

- ▶ Remind the boys of appropriate behavior, including safety considerations, at the site of your visit.
- ▶ Use this time also to discuss participation in upcoming pack meetings or events as needed.
- ▶ Explain that today's meeting is to work on the **Geologist activity badge** and to learn about the science of geology, which deals with the study of rocks, volcanoes, geysers, earthquakes, and mountains.

Activities

- ▶ **Geologist Activity Badge:** Requirements are to do five of nine requirements. (This meeting plan does 1, 2, and 8, and the next meeting covers 4, 5, and 6.):
 1. Collect five geologic specimens that have important uses.
 2. Rocks and minerals are used in metals, glass, jewelry, road-building products, and fertilizer. Give examples of minerals used in these products.
 8. Take a field trip to a geological site, geological laboratory, or rock show. Discuss what you learned at your next Webelos den meeting.
 - As you hike, identify the geological product you walk on and see, including as used in building material of the different buildings you pass by and the streets and sidewalks



you cross. Have each Scout keep a list, or if you've checked it out in advance, make a scavenger hunt list of what they might find on the hike.

- As you hike, collect rocks and minerals and then identify them (while on the hike, or when you return, or at the next meeting). Check local laws before allowing the boys to dig for rocks or minerals. In some states, laws prohibit digging rocks and other things from the ground.
- If your host is in the construction business, have the host talk about geologic materials used in home building, such as slate, brick, limestone, marble, cement, and gypsum.

- ▶ The other requirements for this activity badge that are not included in this meeting or in the next can be used in addition to, or in lieu of, the five selected:
 3. Make a scale of mineral hardness for objects found at home. Show how to use the scale by finding the relative hardness of three samples.
 - A clue to a mineral's identity is its hardness.
 - A hardness scratch test is simple enough to perform in the field. Many experienced rock collectors carry a hardness testing kit on their rock-hunting trips. Knowing the hardness of a mineral will not always tell you its identity, but it will help rule out some possibilities.
 - The kit can be made from materials found around the house or obtained inexpensively. (Note that the kit items are rated according to hardness, in relation to the mineral hardness scale in the *Webelos Handbook*.) One kit for the den should be sufficient. Include the following:
 - Tailor's chalk (softest; your fingernail is a hardness of 2)
 - Copper coin (3)
 - 12-penny iron nail (4 to 4½)
 - Knife with steel blade (about 5½)
 - Hard glass, such as window glass (6)
 - High-speed drill bit (6½)
 - Metal file (6½ to 7½)
 - High-speed masonry drill bit (8½)
 - Abrasive sharpening stone (9)
 - In using the hardness kit, test the mineral specimen on a flat surface. After you have made a test scratch, try to rub the mark away with your fingers. A true scratch will remain.
 - Use a magnifying glass to examine any doubtful marks.
 7. Describe what a fossil is. How is it used to tell how old a formation is? Find two examples of fossils in your area.
 9. While you are a Webelos Scout, earn the **Cub Scout Academics belt loop for Geology**. Requirements:
 1. Define geology.
 2. Collect a sample of igneous, sedimentary, and metamorphic rocks. Explain how each was formed.
 3. Explain the difference between a rock and a mineral.

Den Meeting 9



- Here's a simulation to show how sedimentary layers are formed and what they look like.
 - Materials: Shoebox, aluminum foil, string, sand, pebbles, powdered clay, cement, plaster of paris, shells, and water.
 - Line the box with aluminum foil and tie string around the sides so the box won't break or bulge when you fill it. Fill the box halfway with water.
 - Put in a 1/2-inch-deep mixture of sand and cement and let it settle.

Cement and let it settle

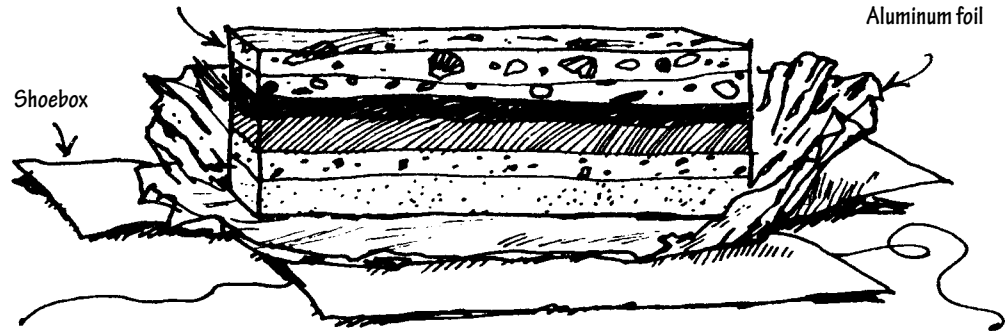

- Then put in 1/2-inch layers of plaster of paris and clay. Let each layer settle.
 - Mix pebbles and shells with a small amount of cement and make a layer of each.
 - When the box is filled, let the "rock" harden for a few days.
 - Cut away the box and you'll have a fair approximation of sedimentary layers.
- In the boys' *Webelos Handbooks*, sign the requirements met (and update your records).

Closing

- Award (or recognize) any advancement completed today; thank hosts, guests, helpers.
- Closing ceremony (rotate planning and leadership to complete **Webelos requirement 6**): Retire the colors; maybe with the Boy Scout Oath and/or Law, or the Law of the Pack and/or den yell. Den leader may add a den leader's minute comment.
- Remind the Webelos Scout who will plan and lead the next meeting's flag ceremony, and remind about home assignments (and include these in any family information letter or e-mail).
- Hand out or send family information letter.

► **Home Assignment:** Review the Geologist chapter in the *Webelos Handbook*.

After the Meeting

- If you've changed the sequence of den meetings, double-check to make sure you will still advance your boys appropriately and check with the Cubmaster to make sure you stay coordinated with the pack.
- Refreshments: If appropriate
- Cleanup: Recruit enough help to do a good job. Scouts always leave an area as clean, or cleaner, than they found it.



LOOK AHEAD!

Arrow of Light den meeting plans do the Sportsman activity badge, which requires two individual sports belt loops and two team sports belt loops!

LOOK AHEAD!

Webelos Den Meeting 10

Geologist

Preparation and Materials Needed

- ▶ Identify any parents or other pack resources who are geologists or rock collectors and could be an activity badge counselor for this meeting.
 - Be sure any guest speaker knows how long the presentation should run, and that you've confirmed what can or should be covered that would be interesting and fun for the Scouts.
 - Show any guest speaker the Geologist chapter in the *Webelos Handbook*.
 - Getting a visitor to bring a rock and mineral collection is a terrific idea.
 - Also, consider having a den chief show how rocks can be used as firestarters!
- ▶ Materials checklist (add to your den Cub tub of U.S./den flags, paper/pencils, other supplies):
 - Bring paper, markers, and pictures (or actual samples) of fossils found in your area.
 - Rock collections, books.
 - Geologist activity badge pins for each of your Scouts (so they can be awarded if completed today).

Before the Meeting

- ▶ Review After the Meeting at the end of the previous den meeting plan for necessary preparation and materials.
- ▶ Make final preparations with assistance from any assistant den leader or other parent helper, den chief, and/or denner. Organize the space (seating, flags, advancement charts, activity materials, handouts, etc.). If you're snacking, organize space for that and the cleanup.

Gathering

- ▶ Have a gathering activity (games, puzzles, other) that will keep Scouts interested and busy and that others may join as they arrive. If the den desires, serve a healthy snack during this time.
- ▶ If you have background materials for the activity badge, Scouts may be interested in reviewing those.
- ▶ Collect dues, record attendance and any advancement completed at home (a good job for an assistant den leader). Assign parents to meeting roles and hand out a meeting plan to each.

Opening

- ▶ Flag ceremony (rotate planning and leadership to complete **Webelos requirement 6**), with Pledge of Allegiance; maybe recite the Cub Scout Promise or sing a patriotic song; perhaps add a roll call, uniform recognition, or den yell.
- ▶ If you have a guest, give a formal introduction, including what the guest will do for you.

Business Items

- ▶ Use this time also to discuss participation in upcoming pack meetings or events as needed.
- ▶ Explain that today's meeting is to complete work on the **Geologist activity badge**.

Activities

- ▶ **Geologist Activity Badge:** Requirements are to do five of nine requirements. (This meeting does 4, 5, and 6. Meeting 9 did 1, 2, and 8.)
 4. List some of the geologic materials used in building your home.
 - Or in building where your den meets.
 5. Make a drawing that shows the cause of a volcano, a geyser, or an earthquake (*Webelos Handbook*, page 290–293).
 - Or do more than a drawing.
 - For earthquakes, you might show the boys how the earth's plates can move, shift, and force down upon each other when you discuss earthquakes:
 - Have each boy put mud in a disposable cake pan. Let dry. Now, have them flex the pan at opposite sides. The earth cracks and shifts. Some pieces break apart; some will fit back together again.
 - For another experiment to demonstrate how strong an earthquake is, you might do this:
 - Fold a sheet of newspaper seven or eight times, and then try to tear it.



- Each sheet of paper represents a layer of the earth.
- It doesn't take much effort to move one layer of newspaper or earth. However, tremendous force is required to move or fold the earth's crust, which is made up of many different layers.
- For earthquakes/tectonic plates, a simple demonstration you can do in a classroom is to move two desks together and place a few items on each desk.
 - Slide the desks against each other.
 - Have the Scouts notice what happens to the items on the desks.
- For volcanoes, you can make a volcano model:
 - Volcanic eruptions happen when pressure builds inside a volcano, forcing ash and lava out the top. In this papier-mâché volcano, you'll use baking soda and vinegar to simulate an eruption.
 - Materials: 12-inch-square wood for base, aluminum foil, baking soda, vinegar, red food coloring, newspaper and wallpaper paste, jar lid, wire coat hangers.
 - Make a cone-shaped base for the papier-mâché by sticking pieces of coat hanger in the wood base diagonally.
 - Fill in under the wires with wadded aluminum foil.
 - Cover the cone with papier-mâché.
 - Leave an opening in the top where the jar lid can be set. Let it dry.
 - Paint with tempera or acrylic paint.
 - Set the jar lid upside down in the top of the volcano.

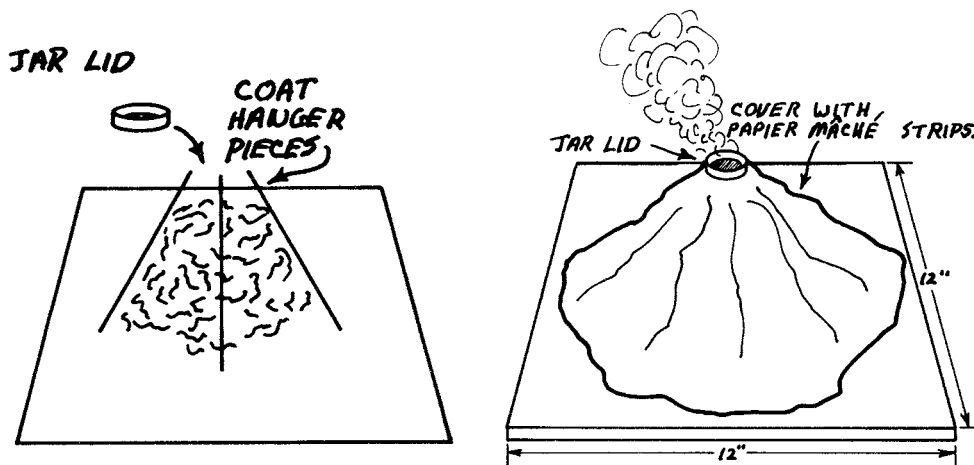

- To make the volcano erupt, place about one teaspoon of baking soda in the jar lid.
- Add ¼ cup of vinegar mixed with a little red food coloring, and watch the action!
- The baking soda and vinegar react to make carbon dioxide gas.
- The gas squirts out of the volcano, bringing the foamy red liquid to the surface. This is safe to do indoors.

6. Explain one way in which mountains are formed.
 - Here's a fun way for Webelos Scouts to build models of different geologic formations.
 - Materials: Modeling clay in at least four different colors, approximately ¼ pound each; talcum powder, a knife, and a straw.
 - When building the models, be sure to put talcum powder between the layers so they can be separated easily.
 - The straw can be used to show underground lakes or rivers. These models make a great display for the pack meeting.

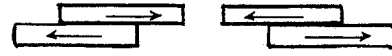
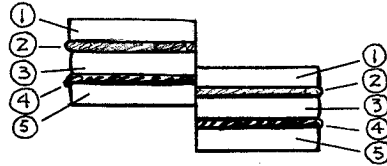
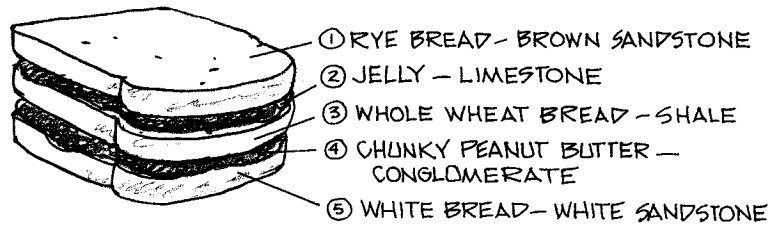

- The same effect as the models illustrated above can be achieved with layered peanut butter and jelly sandwiches to help show how natural forces shape layers or rocks. **Note:** Check for food allergies.
 - Sometimes the earth's crust moves up and down.
 - Cut the sandwiches in half and move one half up or down. This demonstrates a vertical fault, a type of movement that can cause earthquakes.
 - Then slide two parts of the sandwich past each other on the same level. This demonstrates a lateral fault. Boys can now eat their rock layers!

- ▶ In the boys' *Webelos Handbooks*, sign the requirements met (and update your records).

Closing

- ▶ Award (or recognize) any advancement completed today (ideally, award the activity badge, belt loop or compass item completed today, and recognize later at the pack meeting); thank hosts, guests, helpers.
- ▶ Closing ceremony (rotate planning and leadership to complete **Webelos requirement 6**): Retire the colors; maybe with the Boy Scout Oath and/or Law, or the Law of the Pack and/or den yell. Den leader may add a den leader's minute comment.
- ▶ Remind the Webelos Scout who will plan and lead the next meeting's flag ceremony, and remind about home assignments (and include these in any family information letter or e-mail).
- ▶ Hand out or send family information letter.

▶ **Home Assignment:** Review the Engineer chapter in the *Webelos Handbook*.

After the Meeting

- ▶ If you've changed the sequence of den meetings, double-check to make sure you will still advance your boys appropriately and check with the Cubmaster to make sure you stay coordinated with the pack.
- ▶ Refreshments: If appropriate
- ▶ Cleanup: Recruit enough help to do a good job. Scouts always leave an area as clean, or cleaner, than they found it.



Webelos Den Meeting 11

Webelos Engineers

Engineer activity badge (partial).

Preparation and Materials Needed

- ▶ Read the Engineer chapter in the *Webelos Handbook*.
- ▶ Identify any parents or other pack resources who are engineers (civil, mechanical, structural, electrical, aeronautical, chemical, geological, mining, industrial, management, safety, or sanitary) and could be your activity badge counselor for this meeting. Share the Engineer chapter of the *Webelos Handbook* with them.
- ▶ Materials checklist (add to your den Cub tub of U.S./den flags, paper/pencils, other supplies):
 - Paper, pencils and markers for creating floor plans.
 - Combs and balloons to demonstrate static electricity.
 - To make a simple switch, a spring-style clothespin, one D-cell battery, aluminum foil, flashlight bulb, masking tape, scissors, ruler, testing material such as rubber bands, coins, paper clips.
 - Pieces of wood, D-cell flashlight batteries, small bulbs and bulb holders, on/off switches, wire, screws, screwdrivers, awls, cordless drill.
 - If you select alternative activities, see the following pages for additional materials needed for those activities.

Before the Meeting

- ▶ Review After the Meeting at the end of the previous den meeting plan for necessary preparation and materials.
- ▶ Make final preparations with assistance from any assistant den leader or other parent helper, den chief, and/or denner. Organize the space (seating, flags, advancement charts, activity materials, handouts, etc.). If you're snacking, organize space for that and the cleanup.

Gathering

- ▶ Have a gathering activity (games, puzzles, other) that will keep Scouts interested and busy and that others may join as they arrive. If the den desires, serve a healthy snack during this time.
- ▶ If you have background materials for the activity badge, Scouts may be interested in reviewing those.
- ▶ Collect dues, record attendance and any advancement completed at home (a good job for an assistant den leader). Assign parents to meeting roles and hand out a meeting plan to each.

Opening

- ▶ Flag ceremony (rotate planning and leadership to complete **Webelos requirement 6**), with Pledge of Allegiance; maybe recite the Cub Scout Promise or sing a patriotic song; perhaps add a roll call, uniform recognition, or den yell.
- ▶ If you have a guest, give a formal introduction, including what the guest will do for you.

Business Items

- ▶ Use this time also to discuss participation in upcoming pack meetings or events as needed.
- ▶ Explain that today's meeting is to work on the **Engineer activity badge** because engineers solve problems.

Activities

- ▶ **Engineer Activity Badge:** Requirements are to do requirements 1 and 2, and then four of 3 through 10 (This meeting plan does 2, 5, and 6, and the next meeting covers 1, 3, and 4 if you're going to a construction site.):
 2. Draw a floor plan of your house. Include doors, windows, and stairways.
 - Have each Webelos Scout share his floor plan showing his home.
 - **Suggestion:** For more fun, you might turn this into an Extreme Home Makeover, and have them pitch proposals about how they would redo the rooms and locations, and then engage them in discussion of why they need to incorporate foundations, supporting walls, and the like.
 5. Tell about how electricity is generated and then gets to your home.



- See page 216 of the *Webelos Handbook*.
 - **Suggestion:** For more fun, you might do some static electricity tricks. Static electricity is made up of electrons that don't move, unlike current electricity. You can generate static electricity yourself:
 - Run a comb through your hair on a dry day and it will pick up bits of paper.
 - Rub a balloon against your clothing and then it will "hang" on a wall.
 - Wearing socks, but not shoes, drag your feet along a carpet, and then touch a metal object, such as a doorknob. What happens?
 - To see how two electrified objects will repel each other, tie two balloons on a string. Hang them side by side and stroke both of them on a clothing or piece of fur. See how they move apart.
6. Construct a simple working electrical circuit using a flashlight battery, a switch, and a light.
- A switch acts as a kind of bridge along an electrical circuit on which electrons travel. When the switch is closed, the electrons move freely on the electric circuit and complete the electrical connection. When the switch is open, the electrons stop and the connection is incomplete.
 - To make a simple switch, you need spring-style clothespin, one D battery, aluminum foil, flashlight bulb, masking tape, scissors, ruler, testing material such as rubber bands, coins, paper clips. Then:
 - Cut a rectangle of aluminum foil 12 by 24 inches.
 - Fold in half lengthwise five times to form a thin strip 24 inches long.
 - Cut the strip in half to form two 12-inch strips. Tape one end of each strip to the opposite ends of the battery.
 - Wrap the free end of one of the foil strips around the base of the flashlight bulb; hold foil in place with the clothespin.
 - Test the electrical conductivity of several different materials by touching the metal tip of the flashlight bulb to one side of the testing material while touching the free end of the second foil strip to the opposite side of the same testing material.
 - Which objects cause the bulb to glow?
 - Or see *Webelos Handbook* page 217 for a simple electric circuit.

► Other **Engineer activity badge** requirements that could be done in lieu of those selected above and that could be terrific fun are the following:

7. Make drawings of three kinds of bridges and explain their differences. Construct a model bridge of your choice.
8. Make a simple crane using a block and tackle and explain how the block and tackle is used in everyday life. See the *Webelos Handbook*, pages 221–223.
9. Build a catapult and show how it works. See the *Webelos Handbook*, pages 224–225, for one example of a catapult you can make.

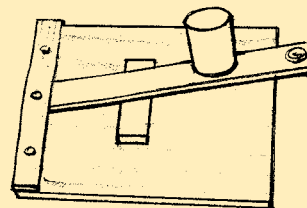
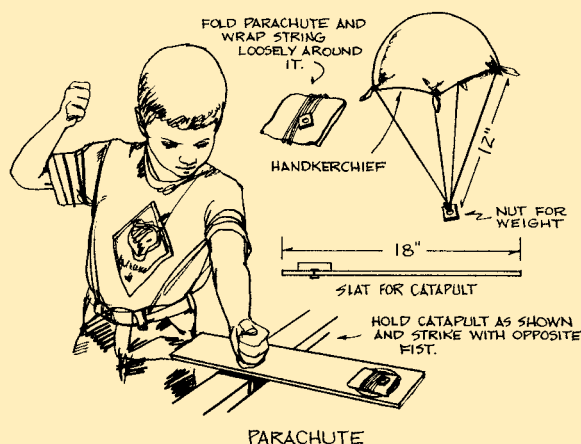
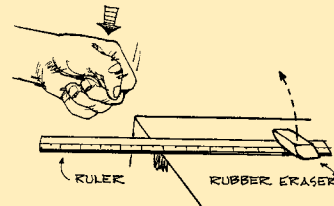
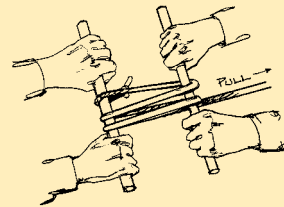

Den Meeting 11



10. While you are a Webelos Scout, earn the **Cub Scout Academics belt loop for Mathematics**. Complete these three requirements:

1. Do five activities within your home or school that require use of mathematics. Explain to your den how you used everyday math.
2. Keep track of the money you earn and spend for three weeks.
3. Measure five items using both metric and non-metric measures. Find out about the history of the metric system of measurement.

- ▶ In the boys' *Webelos Handbooks*, sign the requirements met (and update your records).

Closing

- ▶ Award (or recognize) any advancement completed today; thank hosts, guests, helpers.
- ▶ Closing ceremony (rotate planning and leadership to complete **Webelos requirement 6**): Retire the colors; maybe with the Boy Scout Oath and/or Law, or the Law of the Pack and/or den yell. Den leader may add a den leader's minute comment.
- ▶ Remind the Webelos Scout who will plan and lead the next meeting's flag ceremony, and remind about home assignments (and include these in any family information letter or e-mail).
- ▶ Hand out or send family information letter.

- ▶ **Home Assignment:** Review the Engineer chapter in the *Webelos Handbook*.

After the Meeting

- ▶ If you've changed the sequence of den meetings, double-check to make sure you will still advance your boys appropriately and check with the Cubmaster to make sure you stay coordinated with the pack.
- ▶ Refreshments: If appropriate
- ▶ Cleanup: Recruit enough help to do a good job. Scouts always leave an area as clean, or cleaner, than they found it.



Webelos Den Meeting 12

Engineers Field Trip

Engineer activity badge (complete).

Preparation and Materials Needed

- ▶ Make arrangements to visit a construction site with an engineer or architect. Ask him or her to be prepared to discuss occupations in engineering, to explain how property lines are determined and how to measure the length of a property line, and to have a set of plans for the project available. Obtain hardhats if necessary.
- ▶ Identify any parents or other pack resources who are engineers (civil, mechanical, structural, electrical, aeronautical, chemical, geological, mining, industrial, management, safety, or sanitary) and could be your activity badge counselor for this meeting.
 - Be sure any guest speaker knows how long the presentation should run, and that you've confirmed what can or should be covered that would be interesting and fun for the Scouts.
 - Show any guest speaker the Engineer chapter in the *Webelos Handbook*.
- ▶ If you are doing this as a field trip, inform Scouts and families about when and where to meet.
- ▶ Materials checklist (add to your den Cub tub of U.S./den flags, paper/pencils, other supplies):
 - For a field trip, hardhats if necessary.
 - If you select alternative activities, see meeting A6 for additional materials needed for those activities.
 - Engineer activity badge pins for each of your Scouts (so they can be awarded if completed today), and compass emblems or points (if those will be completed today).

Before the Meeting

- ▶ Review After the Meeting at the end of the previous den meeting plan for necessary preparation and materials.
- ▶ Make final preparations with assistance from any assistant den leader or other parent helper, den chief, and/or denner. Organize the space (seating, flags, advancement charts, activity materials, handouts, etc.). If you're snacking, organize space for that and the cleanup.

Gathering

- ▶ Have a gathering activity (games, puzzles, other) that will keep Scouts interested and busy and that others may join as they arrive. If the den desires, serve a healthy snack during this time.
- ▶ If you have background materials for the activity badge, Scouts may be interested in reviewing those.
- ▶ If you're on a field trip, as boys arrive, collect permission slips from parents who are not staying.
- ▶ Collect dues, record attendance and any advancement completed at home (a good job for an assistant den leader). Assign parents to meeting roles and hand out a meeting plan to each.

Opening

- ▶ Flag ceremony (rotate planning and leadership to complete **Webelos requirement 6**), with Pledge of Allegiance; maybe recite the Cub Scout Promise or sing a patriotic song; perhaps add a roll call, uniform recognition, or den yell.
- ▶ If you have a guest, give a formal introduction, including what the guest will do for you.

Business Items

- ▶ Remind the boys of appropriate behavior, including safety considerations, at the site of your visit.
- ▶ Use this time also to discuss participation in upcoming pack meetings or events as needed.
- ▶ Explain that today's meeting is to complete work on the **Engineer activity badge**, to hear from an engineer and see what he does.

Activities

- ▶ **Engineer Activity Badge:** Requirements are to do requirements 1 and 2 and then four of 3 through 10. (This meeting does 1, 3, and 4 if you're visiting a construction site. Meeting 11 did 2, 5, and 6.)

1. Talk to an engineer, surveyor, or architect in your area about the different occupations in engineering. Create a list that tells what they do.



3. Visit a construction job. Look at a set of plans used to build the facility or product. Tell your Webelos den leader about these. (Get permission before you visit.)
 4. Visit a civil engineer or surveyor to learn how to measure the length of a property line. Explain how property lines are determined.
 - The activities for this meeting are dependent on the information provided by your host at the construction site.
 - Be sure the Scouts take notes about what engineers do.
- Other **Engineer activity badge** requirements that could be done in lieu of 3 and 4 above (if you cannot visit a construction site are described in Den Meeting 11.
 - In the boys' *Webelos Handbooks*, sign the requirements met (and update your records).

Closing

- ▶ Award (or recognize) any advancement completed today (ideally, award the activity badge, belt loop or compass item completed today, and recognize later at the pack meeting); thank hosts, guests, helpers.
- ▶ Closing ceremony (rotate planning and leadership to complete **Webelos requirement 6**): Retire the colors; maybe with the Boy Scout Oath and/or Law, or the Law of the Pack and/or den yell. Den leader may add a den leader's minute comment.
- ▶ Remind the Webelos Scout who will plan and lead the next meeting's flag ceremony, and remind about home assignments (and include these in any family information letter or e-mail).
- ▶ Hand out or send family information letter.

▶ **Home Assignment:** Review the Craftsman chapter in the *Webelos Handbook*.

After the Meeting

- ▶ If you've changed the sequence of den meetings, double-check to make sure you will still advance your boys appropriately and check with the Cubmaster to make sure you stay coordinated with the pack.
- ▶ Refreshments: If appropriate
- ▶ Cleanup: Recruit enough help to do a good job. Scouts always leave an area as clean, or cleaner, than they found it.



*Pinewood derby car for
Craftsman activity badge?*

Webelos Den Meeting 13

Craftsmen (Derby Car Construction)

Craftsman activity badge (partial).

Preparation and Materials Needed

- ▶ Read the Craftsman chapter in the *Webelos Handbook*.
 - Review the Crafts sections in the *Cub Scout Leader How-To Book* for ideas about crafts you or an activity badge counselor could conduct in the den meetings.
- ▶ Identify any parents or other pack resources who are handy with tools and could be your activity badge counselor for this meeting—these might include woodworkers, potters (so consider your art teachers), and arts and crafts hobbyists. If you have such a resource, you might do this meeting as a field trip to the craftsman's workshop. You might see if a local hardware store can host a Craftsman meeting.
 - Be sure any guest speaker knows how long the presentation should run, and that you've confirmed what can or should be covered that would be interesting and fun for the Scouts.
 - Show any guest speaker the Craftsman chapter in the *Webelos Handbook*.
- ▶ Make arrangements for your den to take a field trip to a parent's house that has a good (and safe) area for woodworking. A local hardware store may be willing to assist you for this work.
- ▶ If you are doing this as a field trip, inform Scouts and families about when and where to meet.

▶ **Note:** Power tools are not appropriate for use by Cub Scouts. (See *Age-Appropriate Guidelines for Scouting activities* at www.scouting.org/HealthandSafety/Resources/AgeAppropriateGuidelines).

- ▶ Materials checklist (add to your den Cub tub of U.S./den flags, paper/pencils, other supplies):
 - Pinewood derby car kit for each boy. These can be purchased at your local Scout shop.
 - Bring the rules for your derby about how your cars are to be built.
 - Saws, hammers, wood rasps, drills, weight inserts (washers, fishing weights, or other), sandpaper, paint, decals, smocks. A good scale to weigh the cars is very useful.

Before the Meeting

- ▶ Review After the Meeting at the end of the previous den meeting plan for necessary preparation and materials.
- ▶ Make final preparations with assistance from any assistant den leader or other parent helper, den chief, and/or denner. Organize the space (seating, flags, advancement charts, activity materials, handouts, etc.). If you're snacking, organize space for that and the cleanup.

Gathering

- ▶ Have a gathering activity (games, puzzles, other) that will keep Scouts interested and busy and that others may join as they arrive. If the den desires, serve a healthy snack during this time.
- ▶ If you have background materials for the activity badge, Scouts may be interested in reviewing those.
- ▶ If you're on a field trip, as boys arrive, collect permission slips from parents who are not staying.
- ▶ Collect dues, record attendance and any advancement completed at home (a good job for an assistant den leader). Assign parents to meeting roles and hand out a meeting plan to each.

Opening

- ▶ Flag ceremony (rotate planning and leadership to complete **Webelos requirement 6**), with Pledge of Allegiance; maybe recite the Cub Scout Promise or sing a patriotic song; perhaps add a roll call, uniform recognition, or den yell.
- ▶ If you have a guest, give a formal introduction, including what the guest will do for you.

Business Items

- ▶ Remind the boys of appropriate behavior, including safety considerations, at the site of your visit.
- ▶ Use this time also to discuss participation in upcoming pack meetings or events as needed.
- ▶ Explain that today's meeting is to work on the **Craftsman activity badge** because we want to learn to use tools, and find some craftsman talent that will be useful or may lead to a hobby in one of these areas.



Activities

- ▶ **Craftsman Activity Badge:** Requirements are to do requirements 1–4. (This meeting does 1 and 2 (partial). The next meeting does 3 and 4.)
 1. Explain how to safely handle the tools that you will use for this activity badge safely.
 2. With adult supervision and using hand tools, construct two different wooden objects you and your Webelos den leader agree on, such as the items listed below. Use a coping saw or jigsaw for these projects. Put them together with glue, nails, or screws. Paint or stain them.
 - Many den leaders pick pinewood derby cars as something to build, but two objects need building, and there are many alternatives:

Book rack	Mailbox	Bread box
Napkin holder	Letter holder	Recipe holder
Shelf	Birdhouse	Key rack
Animal cutouts	Notepad holder	Lamp stand
Bulletin board	Desk nameplate	Measuring cup rack
Garden tool rack	Toolbox	Kitchen knife rack
Weather vane	Letter, bill, and pencil holder	Measuring spoon rack
Lid holder	Towel rack	Kitchen utensil rack
Tie rack		

Fun Ideas for Car Design

Focus first on fun designs: Have each Scout use his imagination about what he wants his car to look like. Encourage all to be creative. You may not have the fastest car, but can you have the coolest design?

Here are some crazy ideas:

Coke bottle	Gift wrapped	Bath tub	Beaver on a log
Skateboard	iPod	Cell phone	Banana
Game Boy	Burrito	Camera	Rat
Laptop	Train engine	Pencil	Ambulance
Computer mouse	School bus	Pickup truck	Dragster rocket
Cockroach	Boat	Hot dog	Cheese wedge
Watermelon	Fish	Shark	Batmobile
Tank	Fire truck	Computer	Zamboni

- ▶ In the boys' *Webelos Handbooks*, sign the requirements met (and update your records).

Closing

- ▶ Award (or recognize) any advancement completed today (ideally, award the activity badge, belt loop or compass item completed today, and recognize later at the pack meeting); thank hosts, guests, helpers.
- ▶ Closing ceremony (rotate planning and leadership to complete **Webelos requirement 6**): Retire the colors; maybe with the Boy Scout Oath and/or Law, or the Law of the Pack and/or den yell. Den leader may add a den leader's minute comment.
- ▶ Remind the Webelos Scout who will plan and lead the next meeting's flag ceremony, and remind about home assignments (and include these in any family information letter or e-mail).
- ▶ Hand out or send family information letter.

- ▶ **Home Assignment:** Review the Craftsman and Scholar chapters in the *Webelos Handbook*.

After the Meeting

- ▶ If you've changed the sequence of den meetings, double-check to make sure you will still advance your boys appropriately and check with the Cubmaster to make sure you stay coordinated with the pack.
- ▶ Refreshments: If appropriate
- ▶ Cleanup: Recruit enough help to do a good job. Scouts always leave an area as clean, or cleaner, than they found it.



Webelos Den Meeting 14

More Webelos Craftsmen
Craftsman activity badge (completion).

Preparation and Materials Needed

- ▶ Note that while this is laid out as one meeting, to complete this activity badge you will likely need to use two or more den meeting days—the details of each day depend on the projects you'll complete. If you have several craftsman hobbyist activity badge counselors, you might have separate meetings with each.
 - Alternatively, some may be assigned to be completed at home.
 - This meeting might include completion of items started in prior Craftsman meetings.
- ▶ Read the Craftsman chapter in the *Webelos Handbook*.
 - Review the Crafts sections in the *Cub Scout Leader How-To Book* for ideas about crafts you or an activity badge counselor could conduct in the den meetings.
- ▶ Identify any parents or other pack resources who are handy with tools and could be your activity badge counselor for this meeting—these might include woodworkers, potters (so consider your art teachers), and arts and crafts hobbyists. If you have such a resource, you might do this meeting as a field trip to the craftsman's workshop. You might see if a local hardware store can host a Craftsman meeting.
 - Be sure any guest speaker knows how long the presentation should run, and that you've confirmed what can or should be covered that would be interesting and fun for the Scouts.
 - Show any guest speaker the Craftsman chapter in the *Webelos Handbook*.
- ▶ If you are doing this as a field trip, inform Scouts and families about when and where to meet.
- ▶ Materials checklist (add to your den Cub tub of U.S./den flags, paper/pencils, other supplies):
 - Tools and material to construct two different wooden objects (see the list below).
 - Tools and material to make a display stand or box to be used to display a model or an award, or a frame for a photo or painting.
 - Tools and material to make four items out of clay, plastic, leather, metal, paper, rubber, or rope.
 - Craftsman activity badge pins for each of your Scouts (so they can be awarded if completed today), and compass emblems or points (if those will be completed today).

Before the Meeting

- ▶ Review After the Meeting at the end of the previous den meeting plan for necessary preparation and materials.
- ▶ Make final preparations with assistance from any assistant den leader or other parent helper, den chief, and/or denner. Organize the space (seating, flags, advancement charts, activity materials, handouts, etc.). If you're snacking, organize space for that and the cleanup.

Gathering

- ▶ Have a gathering activity (games, puzzles, other) that will keep Scouts interested and busy and that others may join as they arrive. If the den desires, serve a healthy snack during this time.
- ▶ If you have background materials for the activity badge, Scouts may be interested in reviewing those.
- ▶ If you're on a field trip, as boys arrive, collect permission slips from parents who are not staying.
- ▶ Collect dues, record attendance and any advancement completed at home (a good job for an assistant den leader). Assign parents to meeting roles and hand out a meeting plan to each.

Opening

- ▶ Flag ceremony (rotate planning and leadership to complete **Webelos requirement 6**), with Pledge of Allegiance; maybe recite the Cub Scout Promise or sing a patriotic song; perhaps add a roll call, uniform recognition, or den yell.
- ▶ If you have a guest, give a formal introduction, including what the guest will do for you.

Business Items

- ▶ Remind the boys of appropriate behavior, including safety considerations, at the site of your visit.
- ▶ Use this time also to discuss participation in upcoming pack meetings or events as needed.
- ▶ Explain that today's meeting is to work on the **Craftsman activity badge** because we want to learn to use tools, and find some craftsman talent that will be useful or may lead to a hobby in one of these areas.

Activities

- ▶ **Craftsman Activity Badge:** Requirements are to do requirements 1–4. (This meeting does 3 and 4. Den Meeting 14 did 1 and 2.)



3. Make a display stand, or box to be used to display a model or an award. Or make a frame for a photo or painting. Use suitable material.
 - You might make pinewood derby display stands for your pack.
 - See the design at page 205 of the *Webelos Handbook* for one idea on how to make those.
4. Make four useful items using materials other than wood that you and your Webelos den leader agree on, such as clay, plastic, leather, metal, paper, rubber, or rope. These should be challenging items and must involve several operations.

- One might be a *Boys' Life* binder:
This binder will hold a year's worth of *Boys' Life* issues.
- Materials: 12-by-20-inch piece of leather or imitation leather, 6 feet of plastic or leather lacing, 1/4-inch leather punch, hammer, wood block, sack needle, cardboard gauge, nail

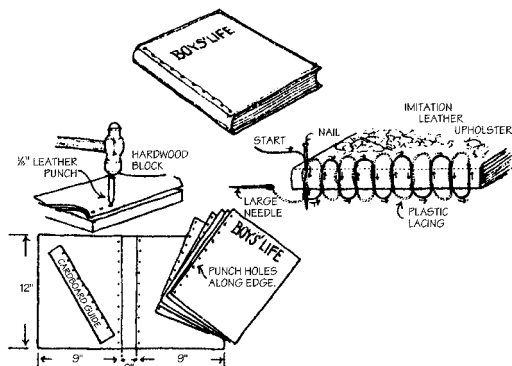

- a. Use a cardboard gauge to mark an even row of 10 holes along the back edge of each magazine, 1 inch apart and 1/4 inch from the edge. Place a hardwood block under the magazine while driving the punch through.
- b. Punch two rows of holes down the center of the cover, spaced 2 inches apart, center to center. Use the same cardboard gauge to mark these holes.
- c. Lace the magazines and cover together. Run half the length of lacing through the bottom hole. Using a sack needle, run both ends through the next hole (one from the top; one from the bottom) so that each end comes out on the opposite side. A nail inserted in the top hole will keep it all in line. Keep the lacing pulled tight and continue to the top hole.
- d. Tie the lacing at the back of book with a square knot. Cut off excess. Trim the cover, allowing for an extra 1/4 inch over the edges of the magazines.
- e. The cover can be tooled with the words "Boys' Life" and the year.

- This meeting might include completion of pinewood derby cars as one of the two objects.

If more time is needed, especially to complete 2–4, consider assigning as a family project.

- ▶ In the boys' *Webelos Handbooks*, sign the requirements met (and update your records).

Closing

- ▶ Award (or recognize) any advancement completed today (ideally, award the activity badge, belt loop or compass item completed today, and recognize later at the pack meeting); thank hosts, guests, helpers.
- ▶ Closing ceremony (rotate planning and leadership to complete **Webelos requirement 6**): Retire the colors; maybe with the Boy Scout Oath and/or Law, or the Law of the Pack and/or den yell. Den leader may add a den leader's minute comment.
- ▶ Remind the Webelos Scout who will plan and lead the next meeting's flag ceremony, and remind about home assignments (and include these in any family information letter or e-mail).
- ▶ Hand out or send family information letter.

▶ Home Assignments:

- **Scholar 11:** Ask a parent and five other grown-ups these questions:
 - What do you think are the best things about my school?
 - What could be done to improve it?
- Tell what you think were the best answers and why.
- Review the Scholar and Artist chapters in the *Webelos Handbook*.

After the Meeting

- ▶ If you've changed the sequence of den meetings, double-check to make sure you will still advance your boys appropriately and check with the Cubmaster to make sure you stay coordinated with the pack.
- ▶ Refreshments: If appropriate
- ▶ Cleanup: Recruit enough help to do a good job. Scouts always leave an area as clean, or cleaner, than they found it.



Webelos Den Meeting 15

Scholar and Artist

Scholar activity badge (complete).

Preparation and Materials Needed

- ▶ Read the Artist chapter in the *Webelos Handbook*.
- ▶ Identify any parents or other pack resources who are artists and could be your activity badge counselor for this meeting. An artist may be an art teacher or anyone who has talent in drawing, painting, sculpting, animation, cartooning, pottery or crafts. See if the artist can visit your den meeting, or you might do this meeting as a field trip to the artist's studio or classroom.
 - Be sure any guest speaker knows how long the presentation should run, and that you've confirmed what can or should be covered that would be interesting and fun for the Scouts.
 - Show them the Artist chapter in the *Webelos Handbook*.
- ▶ If you are doing this as a field trip, inform Scouts and families about when and where to meet.
- ▶ Materials checklist (add to your den Cub tub of U.S./den flags, paper/pencils, other supplies):
 - Items to create a scrapbook. The scrapbook should be sturdy enough to protect the artwork from weather and accidents, but it should be easy to carry. It could be a binder containing pocket folders or a large file folder. It may be as simple as construction paper stapled together in book form with space for gluing boys' artwork.
 - Paper, pencils, lamp, tape, construction paper cut to bookmark size, assorted magazines.
 - Assorted objects to make mobiles, such as dowel rods, coat hanger wire, craft sticks for small mobiles, or pieces of children's toys, and whatever your imagination sees, as choices for the main structure. Thin wire, heavy thread, yarn, or fishing line to suspend the ornaments.
 - Hammer, nails, and large wooden blocks to create a template for bending wire for the mobiles.
 - Items for any other elements you determine you want the Scouts to create.
 - Towels, soap, and water for cleanup.
 - Artist activity badge pins for each of your Scouts (so they can be awarded if completed today), and compass emblems or points (if those will be completed today).
- ▶ Read the Scholar chapter in the *Webelos Handbook*.
- ▶ Identify any parents or other pack resources who are educators and could be your activity badge counselor for this meeting. Or you might see if a teacher or principal from a local school would serve in that role—this meeting can really work well with a respected guest speaker.
 - Be sure any guest speaker knows how long the presentation should run, and that you've confirmed what can or should be covered that would be interesting and fun for the Scouts.
 - Show any guest speaker the Scholar chapter in the *Webelos Handbook*.
- ▶ If you are doing this as a field trip, inform Scouts and families about when and where to meet.
- ▶ Materials checklist (add to your den Cub tub of U.S./den flags, paper/pencils, other supplies):
 - You might bring old school books from when you or an even older relative went to school.
 - Scholar activity badge pins for each of your Scouts (so that they can be awarded if completed today), and compass emblems or points (if those will be completed today).

Before the Meeting

- ▶ Review After the Meeting at the end of the previous den meeting plan for necessary preparation and materials.
- ▶ Make final preparations with assistance from any assistant den leader or other parent helper, den chief, and/or denner. Organize the space (seating, flags, advancement charts, activity materials, handouts, etc.). If you're snacking, organize space for that and the cleanup.

Gathering

- ▶ Have a gathering activity (games, puzzles, other) that will keep Scouts interested and busy and that others may join as they arrive. If the den desires, serve a healthy snack during this time.
- ▶ If you have background materials for the activity badge, Scouts may be interested in reviewing those.
- ▶ If you're on a field trip, as boys arrive, collect permission slips from parents who are not staying.
- ▶ Collect dues, record attendance and any advancement completed at home (a good job for an assistant den leader). Assign parents to meeting roles and hand out a meeting plan to each.

Opening

- ▶ Flag ceremony (rotate planning and leadership to complete **Webelos requirement 6**), with Pledge of Allegiance; maybe recite the Cub Scout Promise or sing a patriotic song; perhaps add a roll call, uniform recognition, or den yell.
- ▶ If you have a guest, give a formal introduction, including what the guest will do for you.



Business Items

- ▶ Remind the boys of appropriate behavior, including safety considerations, at the site of your visit.
- ▶ Use this time also to discuss participation in upcoming pack meetings or events as needed.
- ▶ Explain that today's meeting is to work on the **Scholar activity badge** because of the importance of education and the school system.
- ▶ **Verify:** During the meeting or by reviewing the boys' handbooks, confirm completion of **Scholar 11**.

Activities

- ▶ **Scholar Activity Badge:** Requirements are to do this first requirement, and then three of 2 through 13 (This meeting plan does 1, plus 5, 11, and 12.):
 1. With your parent, guardian, or Webelos den leader, complete the Positive Attitude Character Connection.
 - a. **Know:** Discuss with your parent, guardian, or your Webelos den leader, what it means to have a positive attitude and the "BEST" steps you can take to have a positive attitude. (**B**elieve it can happen, **E**xpect success, **S**et your mind, and **T**ry, try, try.)
 - b. **Commit:** Plan with your parent, guardian, or your Webelos den leader, how you will apply the "BEST" steps for a positive attitude in doing your schoolwork and in other areas of your life.
 - c. **Practice:** Do your "BEST" to have a cheerful and positive attitude while doing the requirements for this activity badge.
 5. List in writing some important things you can do now because of what you've learned in school.
 11. Ask a parent and five other grown-ups these questions:
 - What do you think are the best things about my school?
 - What are its main problems?
 - Tell what you think were the best answers and why.
 - Have boys share the responses with their den members.
 12. List and explain some of the full-time positions in the field of education.

Other Ways to Complete the Scholar Activity Badge

Other requirements that could be done in addition to, or in lieu of, 5, 11, and 12 are:

2. Have a good record in attendance, behavior, and grades at school.
 3. Take an active part in a school activity or service.
 4. Discuss with your teacher or principal the value of having an education.
 6. While you are a Webelos Scout, earn the **Cub Scout Academics belt loop for Language**.
 7. While you are a Webelos Scout, and if you have not earned it for another activity badge, earn the **Cub Scout Academics belt loop for Mathematics**.
 8. While you are a Webelos Scout, earn the **Cub Scout Academics belt loop for Chess**.
 9. Trace through history the different kinds of schools. Tell how our present public school system grew out of these early schools.
 10. Make a chart showing how your school system is run.
 13. Help another student with schoolwork. Tell what you did to help.
- ▶ **Artist Activity Badge.** You might need to work in completion of Artist projects begun last meeting, but not yet complete.
 2. Create a scrapbook (portfolio) of your **Artist activity badge** projects and show it to your den leader.
 - As boys create works of art, the scrapbook or portfolio is used to keep the work safe. The scrapbook should be a complete collection of the boy's work, even if some of it isn't finished.
 - He can be proud of all of it! (Be sure to praise the good elements of the work.)
 8. Make a mobile, using your choice of materials.
 - See the material list above, and use your imagination and that of your Scouts.
 - Here's a helpful way of shaping wire for mobiles and constructions. Draw an outline of your design on paper. Place the paper on a wooden block and drive nails part of the way in along the outline. Wind wire around the nails, and you have your wire shapes.
 - Use the dowel rods, coat hanger wire, craft sticks, pieces of children's toys and other items for the main structure. Then use thin wire, heavy thread, yarn, or fishing line to suspend the ornaments you make to hang on the mobile structure.



10. Create a collage that expresses something about you.

- *Collage* is a French word describing a work of art created by pasting different items onto a surface. You can use just about anything you want to create a collage: old photographs, greeting cards, magazine pictures, or even junk mail.
- Choose a subject for your collage that tells something about you, about what Cub Scouting means to you, or about a friend, a pet, or your favorite sport. Find some pictures about your subject and arrange them in an interesting way on a piece of cardboard. When you are pleased with your design, paste the pictures down. Use a thin, even coat of paste so that the pictures don't wrinkle.

Want More Fun Activities?

Play Tag Team Art:

- ▶ Line members up in relay fashion (this may be done in teams). Have a large piece of paper taped on the wall or hung on an easel. Have the first boy begin drawing an object or design on the paper, without telling anyone what he is drawing. Allow him 30 seconds, and then signal for the next boy. This boy adds to the original picture or design. Each boy follows in turn, each having 30 seconds as the artist.
- ▶ When each boy has had a turn or two (depending on how the picture is taking shape), signal a stop.
- ▶ After all have had time to admire their handiwork, have the first boy share what his original intent was for the drawing.

Or play Artist Charades:

- ▶ Divide the group into two teams. Each has a large sheet of paper. Teams line up in relay fashion.
- ▶ On a signal, the first boy in each line runs to the leader, who gives him the name of an object to draw.
- ▶ The boy goes to his paper and begins to draw the object. As he progresses with his artwork, his team tries to guess what he is drawing.
- ▶ When they guess correctly, the next boy in line takes his turn as artist. The game continues until all members have drawn. The team that finishes first wins.

- ▶ In the boys' *Webelos Handbooks*, sign the requirements met (and update your records).

Want More Fun Activities?

Having done or started Webelos I Den Meeting 4 ("Athletes Practice Fitness"), you will have a good, active, physical activity to insert in this meeting (which has more talk and research, and a need for physical action).

- ▶ Taking a break to check on *just one* of those can be a good active break in your meeting.

Closing

- ▶ Award (or recognize) any advancement completed today (ideally, award the activity badge, belt loop or compass item completed today, and recognize later at the pack meeting); thank hosts, guests, helpers.
- ▶ Closing ceremony (rotate planning and leadership to complete **Webelos requirement 6**): Retire the colors; maybe with the Boy Scout Oath and/or Law, or the Law of the Pack and/or den yell. Den leader may add a den leader's minute comment.
- ▶ Remind the Webelos Scout who will plan and lead the next meeting's flag ceremony, and remind about home assignments (and include these in any family information letter or e-mail).
- ▶ Hand out or send family information letter.

After the Meeting

- ▶ If you've changed the sequence of den meetings, double-check to make sure you will still advance your boys appropriately and check with the Cubmaster to make sure you stay coordinated with the pack.
- ▶ Refreshments: If appropriate
- ▶ Cleanup: Recruit enough help to do a good job. Scouts always leave an area as clean, or cleaner, than they found it.



Webelos Den Meeting 16

Puppetry Showmen

Showman Activity Badge (complete).

Preparation and Materials Needed

- ▶ Read the Showman chapter in the *Webelos Handbook*.
 - **Note:** This meeting plans a puppetry-focused version of Showman, and so adds some other elements from Webelos Den Meetings 17 (Music) and 18 (Drama), to complete the activity badge in one meeting.
 - But if you have interest and it fits your schedule, you could cover each element of Showman.
 - Or you may choose to pick a more even mixture from each: Showman requires completion of nine requirements, as long as there is at least one from each of puppetry, music, and drama.
- ▶ Identify any parents or other pack resources (like teachers) who are into performing, crafts, and/or puppetry and who could be your activity badge counselor for this meeting. Alternatively, you might see if a hobbyist can visit your den meeting, or you might do this meeting as a field trip to a site that has lots of puppets.
 - Be sure any guest speaker knows how long you the presentation should run, and that you've confirmed what can or should be covered that would be interesting and fun for the Scouts.
 - Show any guest speaker the Showman chapter in the *Webelos Handbook*.
- ▶ If you are doing this as a field trip, inform Scouts and families about when and where to meet.
- ▶ Materials checklist (add to your den Cub tub of U.S./den flags, paper/pencils, other supplies):
 - See the materials used for the puppetry options you pick from this plan and the *Webelos Handbook*.
 - The *Cub Scout Songbook* or words to a folk song for the Scouts to sing
- **Showman activity badge** pins for each of your Scouts (so they can be awarded if completed today), and compass emblems or points (if those will be completed today)

Before the Meeting

- ▶ Make final preparations with assistance from any assistant den leader or other parent helper, den chief, and/or denner. Organize the space (seating, flags, advancement charts, activity materials, handouts, etc.). If you're snacking, organize space for that and the cleanup.

Gathering

- ▶ Have a gathering activity (games, puzzles, other) that will keep Scouts interested and busy and that others may join as they arrive. If the den desires, serve a healthy snack during this time.
- ▶ If you have background materials for the activity badge, Scouts may be interested in reviewing those.
- ▶ If you're on a field trip, as boys arrive, collect permission slips from parents who are not staying.
- ▶ Collect dues, record attendance and any advancement completed at home (a good job for an assistant den leader). Assign parents to meeting roles and hand out a meeting plan to each.

Opening

- ▶ Flag ceremony (rotate planning and leadership to complete **Webelos requirement 6**), with Pledge of Allegiance; maybe recite the Cub Scout Promise or sing a patriotic song; perhaps add a roll call, uniform recognition, or den yell.
- ▶ If you have a guest, give a formal introduction, including what the guest will do for you.

Business Items

- ▶ Remind the boys of appropriate behavior, including safety considerations, at the site of your visit.
- ▶ Use this time to discuss participation in coming pack meetings or pack events, as needed.
- ▶ Explain that today's meeting is to work on the **Showman activity badge** because we want to get exposed to theater and music arts, to build self-confidence by performing, and to have fun.



Activities

- ▶ The **Showman activity badge** requirements are to complete nine requirements from among the puppetry, music, and drama requirements offered, as long as there is at least one requirement completed from each of the puppetry, music, and drama areas.
 - This is a puppetry plan, and adds music and drama requirements to complete the activity badge.
- ▶ Puppetry Activities:
 - **Showman 2:** Write a puppet play about one of your Webelos den activities or a subject of your choice.
 - One way to handle the play-writing phase of this badge is to let Webelos Scouts produce a film, using a home camcorder to record the action.
 - This is a unique opportunity that should excite the boys. Let the boys write the script, choose someone to direct and film it, and act in it. You'll find that ideas for the plot will come easily.
 - **Showman 3:** Make a set of puppets or marionettes for the play you have written or for another play.
 - **Showman 7:** There are sock, stick, and finger puppets. There are paper bag puppets and marionettes. Explain their differences and show any puppets you have made for this badge.
 - There are many kinds of puppets—see the *Webelos Handbook*, pages 435–437, and these ideas:

Finger Puppet

- ▶ The finger puppet is a good introduction to puppetry because it's so easy to make.
- ▶ Cut it out from construction paper or other heavy stock, and then paint or decorate with colored markers.
- ▶ Also use yarn for hair, buttons for eyes, and ribbon for bow ties.
- ▶ Use a felt-tip pen for additional features. Attach to fingers with a rubber band.
- ▶ Your fingers form legs.

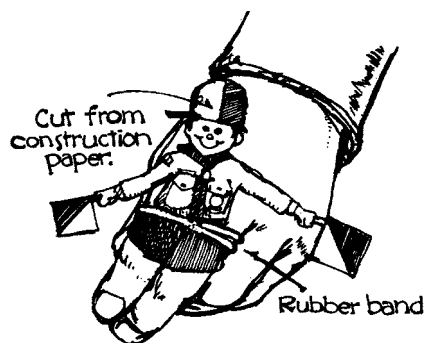

Finger Puppet

Egg Carton Finger Puppets

- ▶ Cut the cups from a cardboard egg carton. Decorate as desired.
- ▶ To help the puppets stay on your fingers, wind a 3-inch piece of cellophane tape around your finger, sticky side out.
- ▶ Tuck this tape inside the puppet.
- ▶ When you put the puppet on your finger, it will stay in place.
- ▶ Animal heads can be made by using two cups glued together.
- ▶ Use pieces of the egg carton lid to make ears or antlers.

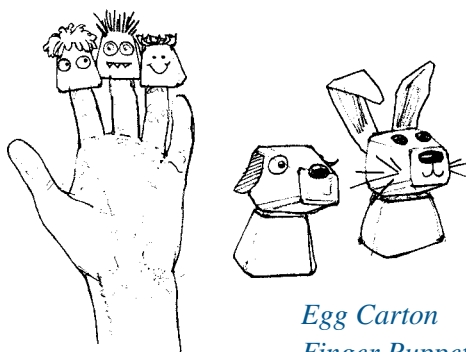

Egg Carton Finger Puppets

Dancing Stick Puppet

- ▶ Cut parts from heavy cardboard or plastic.
- ▶ Decorate with marking pens.
- ▶ Punch holes for joints and assemble with heavy brass paper fasteners.
- ▶ With a needle, run heavy thread between the right elbow and knee and between the left elbow and knee; tie each.
- ▶ Have one loop of thread tied at the elbow and feet for the operator to use to work the puppet.
- ▶ Attach a dowel to the puppet's back for support.

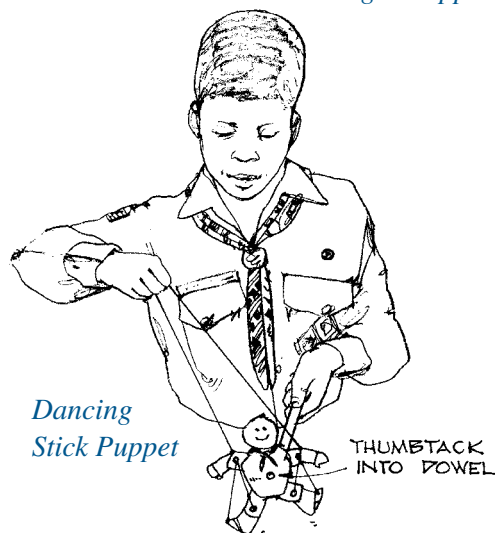

Dancing Stick Puppet



Cylinder Hand Puppets

- ▶ Use cardboard toilet tissue cores to make these puppets.
- ▶ Features can be made with made with cardboard, construction paper, yarn, cotton balls, paint, markers and other craft materials.

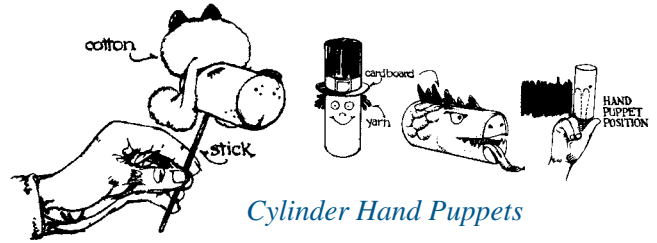

Cylinder Hand Puppets

Kneesie Puppets

- ▶ A type of sock puppet.
- ▶ The puppet's body is a sock coming up to the knee.
- ▶ Draw the puppet's face on the knee with lipstick and eyebrow pencil.
- ▶ For the arms, cut a second sock as shown and sew to the body.
- ▶ Hands and feet are pieces of felt.
- ▶ String arms to a stick so the puppeteer can manipulate them.

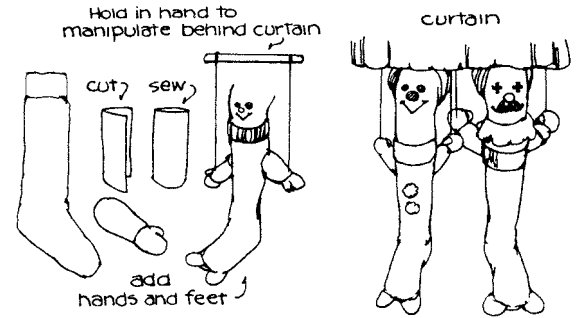

Kneesie Puppets

Footsie Puppets

- ▶ Create puppet faces on the soles of socks.
- ▶ Sew or glue scraps of felt for facial features, or use construction paper, yarn, and other materials.
- ▶ Make the footsie theater from a cardboard carton.
- ▶ The curtain is made of crepe paper strips affixed along the top.
- ▶ Put a smaller carton underneath as a resting place for legs.
- ▶ The puppeteer can stay out of sight beneath a sheet or lightweight blanket.

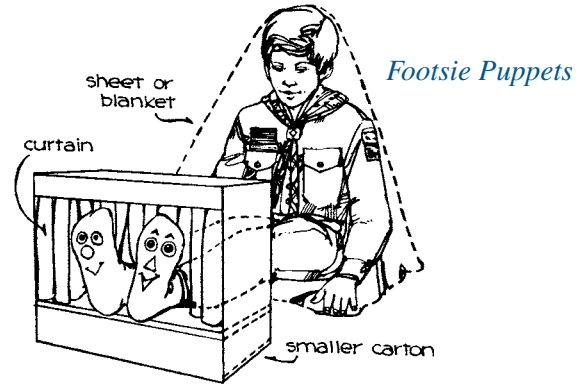

Footsie Puppets

Glove Puppets

- ▶ Supply each boy with a work glove to decorate as a puppet; gloves come in assorted styles and textures and can be decorated with pieces of felt, pom-poms, glitter, etc.
- ▶ Insert the glove through a hole in a large cardboard box that is decorated to match the style of the puppet (for instance, decorate the box as a jungle for a tiger glove puppet).
- ▶ To animate the puppets, boys can insert their hand into the glove or move the puppet with a stick inserted into the glove.
- ▶ White gloves decorated with black dots make great Dalmatian puppies in a basket. A green glove could become a family of caterpillars on a tree limb. An orange glove could become a family of tigers or giraffes if you add stripes or spots.
- ▶ Brown gloves can be used as reindeer with brown chenille stick antlers; have the glove peek out of a chimney, or make a cardboard sleigh.
- ▶ More puppet options will come from the imaginations of your Scouts and the *Cub Scout Leader How-To Book*.
 - **Showman 4:** Build a simple stage for marionettes or puppets.
 - See the Webelos Handbook, pages 438–439, and the *Cub Scout Leader How-To Book*.
 - **Showman 6:** Make a set of four paper bag puppets for a singing group. With the help of three other den members, sing a song with the puppets as the performers.



Paper Bag Puppets

- ▶ These can be simple, with the bag completely open and the face done on one side.
- ▶ They could be more complex, with the face using the “bottom fold-over” as a “flap” so if you open that flap, you can draw a mouth in/under there. Or it could have eyes that open and close.
- ▶ Your puppet’s features may be drawn directly on the paper bag, but a more interesting puppet results when features are made with bits of colored felt, construction paper, or other materials. Use bright colors.

Paper Bag Puppets

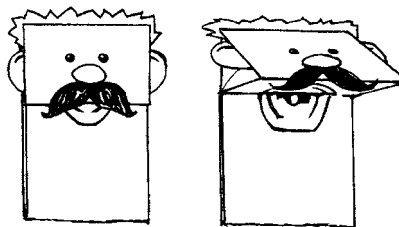

- ▶ To give the impression of speaking to your puppet, put the top of the mouth at the bottom of the flap, and put the bottom lip directly underneath on the front of the bag. This will cause the lips to meet.
- ▶ Open the flap and finish the mouth so that it will be continuous. (See top illustration.)
- ▶ For a puppet that will open its eyes and then close them, locate the tops of the eyes at the bottom of the flap and directly under the flap front of the bag.

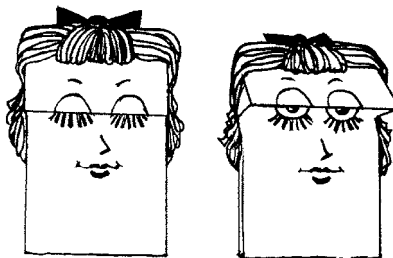

- Under the flap, make the eyes open.
 - **Showman 5:** Alone or with the help of others, put on a puppet show for your den or pack.
 - Music activities (you could pick another item from requirements 8 to 15 if you choose):
 - **Showman 11:** Tell what folk music is. Hum, sing, or play a folk tune on a musical instrument.
- ▶ See Page 441 of the *Webelos Handbook*. For example, “This Land Is Your Land.”
- ▶ Drama activities (you could pick other items from requirements 16 to 23 if you choose):
 - **Showman 17:** Attend a play. Describe the story. Tell what you liked about it.
 - Here the Scouts get to be drama critics as they watch a puppet play put on by another Scout or group of Scouts in the den.
 - **Showman 20:** Make a list of stage directions. Tell what they mean.
 - Have this incorporated into the puppet plan put on by the Scouts.
 - In the boys’ *Webelos Handbooks*, sign the requirements met (and update your records).

Closing

- ▶ Award (or recognize) any advancement completed today (ideally, award the activity badge, belt loop, or compass item completed today, and recognize later at the pack meeting); thank hosts, guests, and helpers.
- ▶ Closing ceremony (rotate planning and leadership to complete **Webelos requirement 6**): Retire the colors; maybe with the Boy Scout Oath and/or Law, or the Law of the Pack and/or den yell. Den leader may add a den leader’s minute comment.
- ▶ Remind the Webelos Scout who will plan and lead the next meeting’s flag ceremony, and remind about home assignments (and include these in any family information letter or e-mail).
- ▶ Hand out or send family information letter.

After the Meeting

- ▶ If you’ve changed the sequence of den meetings, double-check to make sure you will still advance your boys appropriately and check with the Cubmaster to make sure you stay coordinated with the pack.
- ▶ Refreshments: If appropriate
- ▶ Cleanup: Recruit enough help to do a good job. Scouts always leave an area as clean, or cleaner, than they found it.



Webelos Den Meeting 17

Musical Showmen

Showman Activity Badge (complete). Music Belt Loop.

Preparation and Materials Needed

- ▶ Read the Showman chapter in the *Webelos Handbook*.
 - **Note:** This meeting plans a music-focused version of Showman, and so adds some other elements from Webelos Den Meetings 16 (Puppetry) and 18 (Drama), to complete the activity badge in one meeting.
 - But if you have interest and it fits your schedule, you could cover each element of Showman.
 - Or you may choose to pick a more even mixture from each: Showman requires completion of nine requirements, as long as there is at least one from each of puppetry, music and drama.
- ▶ Identify any parents or other pack resources (like teachers) who are musicians, singers, or have ability in those areas and could be your activity badge counselor for this meeting. This may be a music teacher at school, and the meeting could be done in the music teacher's studio.
 - Be sure any guest speaker knows how long you the presentation should run, and that you've confirmed what can or should be covered that would be interesting and fun for the Scouts.
 - Show any guest speaker the Showman chapter in the *Webelos Handbook*.
- ▶ For this activity badge to be completed today will require advance assignment at home:
 - **Showman 10:** Make a collection of three or more records, tapes, or music CDs. Tell what you like about each one.
 - They can be encouraged to bring these in, but that is not required.
 - For the new millennium, collected downloads would suffice!
- ▶ If you are doing this as a field trip, inform Scouts and families about when and where to meet.
- ▶ Materials checklist (add to your den Cub tub of U.S./den flags, paper/pencils, other supplies):
 - The *Cub Scout Songbook* or words to a folk song for the Scouts to sing.
 - **Showman activity badge** pins and **Music belt loops** for each of your Scouts (so that they can be awarded if completed today), and compass emblems or points (if those will be completed today)

Before the Meeting

- ▶ Make final preparations with assistance from any assistant den leader or other parent helper, den chief and/or denner. Organize the space (seating, flags, advancement charts, activity materials, handouts, etc.). If you're snacking, organize space for that and cleanup.

Gathering

- ▶ Have a gathering activity (games, puzzles, other) that will keep Scouts interested and busy and that others may join as they arrive. If the den desires, serve a healthy snack during this time.
- ▶ If you have background materials for the activity badge, Scouts may be interested in reviewing those.
- ▶ If you're on a field trip, as boys arrive, collect permission slips from parents who are not staying.
- ▶ Collect dues, record attendance and any advancement completed at home (a good job for an assistant den leader). Assign parents to meeting roles and hand out a meeting plan to each.

Opening

- ▶ Flag ceremony (rotate planning and leadership to complete **Webelos requirement 6**), with Pledge of Allegiance; maybe recite the Cub Scout Promise or sing a patriotic song; perhaps add a roll call, uniform recognition, or den yell.
- ▶ If you have a guest, give a formal introduction, including what the guest will do for you.

Business Items

- ▶ Remind the boys of appropriate behavior, including safety considerations, at the site of your visit.
- ▶ Use this time to discuss participation in coming pack meetings or events, as needed.
- ▶ Explain that today's meeting is to work on the **Showman activity badge** because we want to get exposed to theater and music arts, to build self-confidence by performing, and to have fun singing.



Activities

- ▶ The **Showman activity badge** requirements are to complete nine requirements from among the puppetry, music, and drama requirements offered, as long as there is at least one requirement completed from each of the puppetry, music, and drama areas.
- ▶ This is a music plan, and adds puppetry and drama requirements to complete the activity badge.
- ▶ Music: Do one of these not already done for **requirement 1**:
 - **Showman 9**: Sing one song indoors and one song outdoors, either alone or with a group. Tell what you need to do differently when singing outdoors.
 - See the *Cub Scout Songbook*, and your activity badge counselor may have ideas.
 - **Showman 10**: Make a collection of three or more records, tapes, or music CDs. Tell what you like about each one.
 - If anyone has brought some of their collection, you might have show and tell (and sing).
 - **Showman 11**: Tell what folk music is. Hum, sing, or play a folk tune on a musical instrument.
 - See Page 441 of the *Webelos Handbook*. For example, you could sing “This Land Is Your Land.”
 - An activity badge counselor may have other ideas.
 - **Showman 12**: Name three American composers. Name a famous work by each.
 - See Pages 442–443 of the *Webelos Handbook*.
 - **Showman 13**: Draw a staff. Draw on it a clef, sharp, flat, natural, note, and rest. Tell what each is used for.
 - See Page 444 of the *Webelos Handbook*.
 - **Showman 14**: Show the difference between 2/4, 3/4, and 4/4 time by beating time or playing an instrument.
 - Not explained in the handbook, you’ll need your activity badge counselor to help.
 - **Showman 15**: While you are a Webelos Scout, earn the Cub Scout Academics Belt Loop for Music. Complete these three requirements:
 - **Music belt loop 1**: Explain why music is an important part of our culture.
 - **Music belt loop 2**: Pick a song with at least two verses and learn it by heart.
 - **Music belt loop 3**: Listen to four different types of music either recorded or live.
 - Not included here is this requirement, which could be done in lieu of one of the above, or in addition:
 - **Showman 8**: Play four tunes on any band or orchestra instrument. Read these from music.
 - Puppetry activities (you could pick another item from **Showman 2 to 7** if you choose):
 - **Showman 6**: Make a set of four paper bag puppets for a singing group. With the help of three other den members, sing a song with the puppets as the performers.
- ▶ See Meeting Plan 16 for ideas on making paper bag puppets.
- ▶ Drama activities (you could pick other items from **Showman 16 to 23** if you choose):
 - **Showman 16**: Give a monologue (a talk) on a patriotic, humorous, or holiday subject, or another subject of your choice.
 - Could be serious, could be comedy.
 - Stand-up comedy is when someone delivers a humorous monologue—which is when a solo actor recites or acts out a play or gives a talk on any topic.
 - Let your boys warm up your next den meeting by preparing a series of jokes or stories to entertain their den mates. *Boys’ Life* magazine is an excellent source of fresh humor every month.
- ▶ Musical games you might include today:
 - *Song Stumpers*. The first player sings the first line of a familiar song. In turn, the other players try to complete the first verse. If one is successful, he becomes the new leader. If not, the first leader starts a new song.
 - *Musical Chairs*. Place several chairs—one less chair than the number of players—in a line or circle. Start a record or tape recording of music and have the players march around the chairs. When the music suddenly stops, all players will scramble to get to a chair. The one who fails, steps out of the game. Remove one chair and start the music again. Continue until only one player—the winner—is left. Variation: Instead of having players eliminated from the game, score a point against them. At the end of a specified time, the player with the fewest points is the winner.

Den Meeting 17



- *Sing-Along Down.* Players are seated in a circle. The first player chooses any song he likes and sings the first line. The player to his left tries to sing the next line, and so on around the circle, with each player adding one line. If a player doesn't know the line, a point is scored against him, and the next player tries. When the sing-along gets back to the player who started the song, that song ends and another player starts a new one.
- ▶ In the boys' *Webelos Handbooks*, sign the requirements met (and update your records).

Closing

- ▶ Award (or recognize) any advancement completed today (ideally, award the activity badge, belt loop, or compass item completed today, and recognize later at the pack meeting); thank hosts, guests, and helpers.
- ▶ Closing ceremony (rotate planning and leadership to complete **Webelos requirement 6**): Retire the colors; maybe with the Boy Scout Oath and/or Law, or the Law of the Pack and/or den yell. Den leader may add a den leader's minute comment.
- ▶ Remind the Webelos Scout who will plan and lead the next meeting's flag ceremony, and remind about home assignments (and include these in any family information letter or e-mail).
- ▶ Hand out or send family information letter.

After the Meeting

- ▶ If you've changed the sequence of den meetings, double-check to make sure you will still advance your boys appropriately and check with the Cubmaster to make sure you stay coordinated with the pack.
- ▶ Refreshments: If appropriate
- ▶ Cleanup: Recruit enough help to do a good job. Scouts always leave an area as clean, or cleaner, than they found it.



Webelos Den Meeting 18

Dramatic Showmen

Showman Activity Badge (complete).

Preparation and Materials Needed

- ▶ Read the Showman chapter in the *Webelos Handbook*.
 - **Note:** This meeting plans a drama-focused version of Showman, and so adds some other elements from Webelos Den Meetings 16 (Puppetry) and 17 (Music), to complete the activity badge in one meeting.
 - But if you have interest and it fits your schedule, you could cover each element of Showman.
 - Or you may choose to pick a more even mixture from each: Showman requires completion nine requirements, as long as there is at least one from each of puppetry, music and drama.
 - ▶ Identify any parents or other pack resources (like teachers) who are into theater and could be your activity badge counselor for this meeting. Or you might see if a drama teacher or someone from a community theater can visit your den meeting, or you might do this meeting as a field trip to a school or community theater.
 - Be sure any guest speaker knows how long you the presentation should run, and that you've confirmed what can or should be covered that would be interesting and fun for the Scouts.
 - Show any guest speaker the Showman chapter in the *Webelos Handbook*.
 - ▶ If you are doing this as a field trip, inform Scouts and families about when and where to meet.
 - ▶ Materials checklist (add to your den Cub tub of U.S./den flags, paper/pencils, other supplies):
 - Pictures of William Shakespeare's Globe Theatre
 - Props and costumes for the drama options you pick from this plan and the *Webelos Handbook*
- Bring some examples of short plays.
- The *Cub Scout Songbook* or words to a folk song for the Scouts to sing
 - **Showman activity badge** pins for each of your Scouts (so they can be awarded if completed today) and compass emblems or points (if those will be completed today)

Before the Meeting

- ▶ Make final preparations with assistance from any assistant den leader or other parent helper, den chief and/or denner. Organize the space (seating, flags, advancement charts, activity materials, handouts, etc.). If you're snacking, organize space for that and cleanup.

Gathering

- ▶ Have a gathering activity (games, puzzles, other) that will keep Scouts interested and busy and that others may join as they arrive. If the den desires, serve a healthy snack during this time.
- ▶ If you have background materials for the activity badge, Scouts may be interested in reviewing those.
- ▶ If you're on a field trip, as boys arrive, collect permission slips from parents who are not staying.
- ▶ Collect dues, record attendance and any advancement completed at home (a good job for an assistant den leader). Assign parents to meeting roles and hand out a meeting plan to each.

Opening

- ▶ Flag ceremony (rotate planning and leadership to complete **Webelos requirement 6**), with Pledge of Allegiance; maybe recite the Cub Scout Promise or sing a patriotic song; perhaps add a roll call, uniform recognition, or den yell.
- ▶ If you have a guest, give a formal introduction, including what the guest will do for you.

Business Items

- ▶ Remind the boys of appropriate behavior, including safety considerations, at the site of your visit.
- ▶ Use this time to discuss participation in coming pack meetings or events, as needed.
- ▶ Explain that today's meeting is to work on the **Showman activity badge** because we want to get exposed to theater and music arts, to build self-confidence by performing, and to have fun by acting.



Activities

- ▶ The **Showman activity badge** requirements are to complete nine requirements from among the puppetry, music, and drama requirements offered, as long as there is at least one requirement completed from each of the puppetry, music and drama areas.
 - This is a drama plan, and adds puppetry and music requirements to complete the activity badge.
 - **Showman 16:** Give a monologue (a talk) on a patriotic, humorous, or holiday subject, or another subject of your choice.
 - Could be serious, could be comedy.
 - Stand-up comedy is when someone delivers a humorous monologue—which is when a solo actor recites or acts out a play or gives a talk on any topic.
 - Let your boys warm up your next den meeting by preparing a series of jokes or stories to entertain their den mates. Boys' Life magazine is an excellent source of fresh humor every month.
 - **Showman 21:** Describe a theater-in-the-round. What are its good and bad points?
 - **Showman 22:** Explain the difference between a grand opera and a light opera. Explain the difference between a musical and a play.
 - **Showman 23:** Read about William Shakespeare. Draw a picture of his Globe Theatre.
 - For these three requirements, see pages 446–453 of the *Webelos Handbook*.
 - **Showman 18:** Read a play. Make a model stage setting for one of the acts.
 - You can bring examples, or the Scouts can read a play that another Scout has written.
 - **Showman 20:** Make a list of stage directions. Tell what they mean.
 - These should be part of the play that they put on.
 - **Showman 19:** Write, put on, and take part in a one-act play.
 - You might split the den into two groups, to put on separate plays for each other.
 - One way to handle the play-writing phase of this badge is to let Webelos Scouts produce a film, using a home camcorder to record the action.
 - This is a unique opportunity that should excite the boys. Let the boys write the script, choose someone to direct and film it, and act in it. You'll find that ideas for the plot will come easily.
 - **Showman 17:** Attend a play. Describe the story. Tell what you liked about it.
 - Here the Scouts get to be drama critics as they watch a puppet play put on by another Scout or group of Scouts in the den.
- ▶ Puppetry activities (you could pick another item from requirements 2 to 7 if you choose):
 - **Showman 3:** Make a set of puppets or marionettes for the play you have written or for another play.
 - See Meeting Plan 16 for ideas on making puppets.
 - You might have them incorporate this as a ventriloquist act:
 - Have boys write a dialogue that takes place between themselves and a hand puppet they use as a ventriloquist's dummy.
 - It is not very likely that a 10-year-old boy will be a very good ventriloquist, but if he makes wide, exaggerated actions with the puppet, the audience's eyes will be on the puppet rather than the boy.
 - Other alternatives include having another boy off-stage speaking for the dummy, or having the dummy's dialogue recorded on tape.
 - Both of these methods work well, particularly if you have a microphone available.
- ▶ Music activities (you could pick another item from requirements 8 to 15 if you choose):
 - **Showman 11:** Tell what folk music is. Hum, sing, or play a folk tune on a musical instrument.
 - See Page 441 of the *Webelos Handbook*. For example, "This Land Is Your Land."
 - In the boys' *Webelos Handbooks*, sign the requirements met (and update your records).

Den Meeting 18



Closing

- ▶ Award (or recognize) any advancement completed today (ideally, award the activity badge, belt loop, or compass item completed today, and recognize later at the pack meeting); thank hosts, guests, and helpers.
- ▶ Closing ceremony (rotate planning and leadership to complete **Webelos requirement 6**): Retire the colors; maybe with the Boy Scout Oath and/or Law, or the Law of the Pack and/or den yell. Den leader may add a den leader's minute comment.
- ▶ Remind the Webelos Scout who will plan and lead the next meeting's flag ceremony, and remind about home assignments (and include these in any family information letter or e-mail).
- ▶ Hand out or send family information letter.

After the Meeting

- ▶ If you've changed the sequence of den meetings, double-check to make sure you will still advance your boys appropriately and check with the Cubmaster to make sure you stay coordinated with the pack.
- ▶ Refreshments: If appropriate
- ▶ Cleanup: Recruit enough help to do a good job. Scouts always leave an area as clean, or cleaner, than they found it.

Template for Sample Parent Information Letter or E-Mail

Adapted from examples shown at www.scouting.org/CubScouts/Leaders/DenLeaderResources.aspx:

_____, 20__

Dear Webelos den parents:

Today we completed the following requirements or activity badge achievements from your son's *Webelos Handbook*: "_____". Our special guest leaders were _____ and _____, who "_____".

For our next den meeting on _____ day, _____, 20__ at _____, we will be working on these requirements or activity badge achievements from your son's *Webelos Handbook*: "_____". To help prepare, please have your son complete the _____ which he received at the den meeting (if you need another, please let me know) or review those requirements in your son's *Webelos Handbook*. Our special guest leaders planning to assist at that meeting are _____ and _____.

If you would like to assist at this or another meeting, please let me know! Our summary of the den meeting dates, plans and rank requirements to be covered is below.

We have a pack meeting on _____ day, _____, 20__ at _____. The current program for that event is as follows: _____. Our den will _____.

We also have an upcoming pack outing on _____ day, _____, 20__ at _____, where we will _____. Please sign up for that event by contacting _____ or _____.

Finally, let me give two advancement reminders. First, to earn the Webelos badge, your son doesn't have to do EVERYTHING in the book (earning the Webelos badge requires three activity badges, the Arrow of Light requires five more, each with some special requirement about what group—Physical Skills, Mental Skills, Community, Technology, and Outdoor groups—the activity badge is from). We're doing some of the more interesting and challenging ones in our meeting, but the good news is that the program is flexible. There will be other activity badges that can be earned at campouts and other activities.

Second, let me remind you that there are a number of achievements from your son's handbook that must be completed by you at home, and you—as "Akela," a leader—should review those with your son, and sign off in the handbook when it is complete. A list is provided below for your convenience. Some of these (like requirements related to faith) are clearly family matters, many of these are part of what you will do anyway as you raise your son, and others you will be glad to have (like doing chores around the house)!

Thank you for your help in leading all of our great Scouts.

_____, den leader

Phone Numbers: _____

E-Mail Address: _____

Notes:

- ▶ **Be sure to adjust this list as you develop and change the sequence of your meetings.**
- ▶ **Of course, all Scouting is local: your mileage may vary, and so should your plan!**

Upcoming dates and meetings for the Webelos I year (some of these activities that are shown as "one meeting plans" may expand to be covered in two meetings to be sure that the activities are covered in a fun and interesting way):





Date	The Webelos Den Meeting Plans	Requirements and Electives Covered
__/__/__	1: Fitness and Athlete	Fitness 1 and six from 2–8. Athlete 1–7. Bobcat review. Fitness 2–7. Review Forester and Naturalist chapters.
__/__/__	2: Forester and Naturalist	Fitness 2–7. Naturalist 1, 4, 8, and 10. Forester 3, 4, and 9. Review Forester and Naturalist chapters.
__/__/__	3: Forester and Naturalist	Forester 5 and 6. Naturalist 6, 7, and 9. Review Traveler chapter.
__/__/__	4: Traveler and Athlete	Athlete 4–7. Traveler 1, 9–12. Geography belt loop. Webelos 8. Review Citizen chapter.
__/__/__	5: Citizen	Citizenship 1, 3, and 8. Citizenship belt loop. Review Citizen chapter.
__/__/__	6: Citizen	Citizenship belt loop 1 and 3. Citizen 10 and 8. Webelos review 3, 4, and 7. Review Citizen chapter.
__/__/__	7: Citizen	Citizen 2–7 and 9. Webelos 8. Review Artist chapter.
__/__/__	8: Citizen and Artist	Citizen 8. Citizenship belt loop 3. Webelos 1–8. Citizen (make up). Webelos review (make up). Artist 1, 4, 7, and 9. Review Geologist chapter.
__/__/__	9: Geologist	Geologist 1, 2, and 8. Review Geologist chapter.
__/__/__	10: Geologist	Geologist 4, 5, and 6. Review Engineer chapter.
__/__/__	11: Engineer	Engineer 2, 5, and 6. Review Engineer chapter.
__/__/__	12: Engineer	Engineer 1, 3, and 4. Review Craftsman chapter.
__/__/__	13: Craftsman	Craftsman 1 and 2. Review Craftsman, Scholar, and Artist chapters.
__/__/__	14: Craftsman	Craftsman 3 and 4. Scholar 11. Review Scholar and Artist chapters.
__/__/__	15: Scholar	Scholar 1, 5, 11, and 12. Artist 2, 8, and 10
__/__/__	16: Showman (Puppetry)	Showman 2–5, 7, 11, 17, and 20
__/__/__	17: Showman (Music)	Showman 6 and 8–15
__/__/__	18: Showman (Drama)	Showman 3, 11, 16–18, and 20–23

Our plan will be to cover these activity badges in the Arrow of Light year: Aquanaut, Outdoorsman, Readyman, Family Member, and Scientist, and maybe Sportsman, Handyman, and Communication. Some of these may be “one meeting plans,” others may take two or more, and we might also add these into the program this year and/or use some of these at pack weekend activities now or next year or over the summer.

Webelos “At Home” Achievements: Here are the achievements from the boys’ handbooks that must be completed at home, where the parent—as “Akela,” a leader—should review and sign off in the handbook when it is complete (these will be assigned at the right time, as in many cases they will tie into meeting plans):

- ▶ Complete the exercises in *How to Protect Your Children From Child Abuse: A Parent’s Guide*.
- ▶ Webelos badge: requirement 8.
- ▶ Citizen activity badge.
- ▶ Fitness activity badge.
- ▶ Readyman activity badge.
- ▶ For other activity badges, we’ll advise on what is to be done at home.